



2015  
2016

DonCartel®

SOPORTES  
PUBLICITARIOS



La Cartelera y el Equipamiento Comercial, SL

Calle Luis I, Nave 45 A  
Poligono Industrial de Vallecas  
28031 Madrid

Teléfono: 913 805 532  
Móvil: 678 513 395



This catalogue is not a contractual document, therefore DonCartel is not responsible for any typographical or printing mistakes. Prices valid until 31st October of 2016. Prices may change at any time for updating prices.

- VAT, sales taxes or duty taxes are not included in the sale price.
- All prices are per unit, unless indicated otherwise.
- Assembly is not included.
- GRAPHIC IS NOT INCLUDED IN THE ITEM PRICE.
- FREIGHT/TRANSPORT IS NOT INCLUDED, DonCartel is not responsible for any delays or any problems related to the transportation of products, only the transport company will be held liable.
- Verify the size and measurements of the printed graphic before assembling any display.
- Discounts: There are special discounts for the purchase of large quantities of the same item, please consult us. Discounts cannot be used in combination with other promotions.
- Products will remain in our warehouses until we have the verification of payment from your bank.
- Please check our stock before your purchase.



Le présent catalogue n'est pas un document contractuel. DonCartel ne serait être responsable des possibles erreurs typographiques. Prix valables jusqu'au 31 Octobre 2016 (sous réserve d'une information de notre part vous notifiant des modifications de prix avant cette date).

- La TVA et impôts spéciaux ne sont pas inclus dans les prix du présent catalogue.
- Prix unitaires, sauf indication contraire.
- Montage non inclus.
- IMPRESSIONS NON INCLUSES, les dimensions sont en millimètres.
- TRANSPORT NON INCLUS. DonCartel ne serait être tenu responsable des retards ou autres incidents de transport, ceux-ci seront de la responsabilité du client.
- Remarque: vérifiez les mesures d'impression des articles avant son montage.
- Remises: Pour de grandes quantités d'un article, consultez les remises quantitatives. Remises non cumulables entre elles.
- La marchandise restera dans les entrepôts de DonCartel jusqu'à la vérification du paiement par notre banque.
- Assurez-vous de la disponibilité des produits avant toute commande.



O presente catálogo não é um documento contratual, pelo que a DonCartel não se responsabiliza perante possíveis erros tipográficos. Preços válido até 31 de Outubro de 2016 (excepto se existir comunicação de alterações de preços antes).

- O IVA e impostos especiais NÃO estão incluídos nos preços do presente catálogo.
- Preços unitários, excepto indicação contrária.
- Montagem NÃO incluída.
- IMPRESSÕES NÃO INCLuíDAS, as medidas estão em milímetros.
- TRANSPORTE: NÃO INCLuíDO. A DonCartel não se responsabiliza pelos atrasos ou outras incidências de transporte, estas serão da responsabilidade do contratante do referente serviço.
- Nota: Verifique as medidas de impressão do artigo, antes da sua montagem.
- Descontos: Para grandes quantidades de um artigo, consultar "Tabela de descontos". Descontos não acumuláveis entre si.
- A mercadoria permanecerá nos armazéns da DonCartel até se verificar a entrada de valor em conta.
- Consulte a disponibilidade dos artigos antes de realizar o seu pedido.



El presente catálogo no es un documento contractual, por lo que DonCartel no se responsabiliza ante posibles errores tipográficos. Precios válidos hasta el 31 de Octubre del 2016 (salvo comunicación de cambios de precios antes de esa fecha).

- IVA e impuestos especiales no están incluidos en los precios del presente catálogo.
- Precios unitarios, excepto si se indica lo contrario.
- Montajes no incluidos.
- GRÁFICAS NO INCLUIDAS EN LOS PRECIOS.
- TRANSPORTE: NO INCLUIDO. DonCartel no se responsabiliza de retrasos u otras incidencias derivadas del transporte, estas serán por cuenta del contratante de dicho servicio.
- Verifique las medidas de impresión sobre el display, antes del montaje.
- Descuentos:  
Para grandes cantidades de un artículo, consulte descuentos por volumen. Descuentos no acumulables entre si o a otras promociones vigentes.
- La mercancía permanecerá en los almacenes de DonCartel hasta disponer de la verificación del pago por parte de nuestro banco.
- Consulte la disponibilidad de los artículos antes de realizar su pedido.

	EN	FR	PT	ES
	Carry bag included	Avec sac de transport	Inclui bolsa de transporte	Incluye bolsa de transporte
	One sided	Une face	Uma face	Una cara
	Double-Sided	Double face	Dupla face	Doble cara
	With motion	Avec mouvement	Com movimento	Con movimiento
	With light	Eclairé	Com luz	Con luz
	LED Technology	Technologie LED	Tecnologia LED	Tecnologia LED
	Telescopic	Télescopique	Telescópico	Telescópico
	Printed on fabric	Impression sur toile	Impressão têxtil	Impresión sobre textil
	With lock	Avec serrure	Com fechadura	Con cerradura
	Rainproof	Imperméable	Impermeável	Impermeable
	Suitable for outdoor use	Pour l'extérieur	Para exterior	Para exterior
	With spotlights	Avec spot	Com focos	Focos incluidos
	With Adhesive	Avec adhésif	Con adesivo	Con adhesivo
	Cardboard	Carton	Cartão	Cartón
	With suction pad	Avec ventouse	Com ventosa	Con ventosa
	New Item	Nouvel article	Novidade	Producto nuevo
	Lightweight	Poids léger	Leve	Ligero
	Extraweight	Poids supplémentaire	Peso extra	Peso extra
	Flexible	Flexible	Flexível	Basculante
	Magnetic	Aimanté	Magnético	Magnético
	Plug-in	A Brancher	Elétrico	A corriente
	Big Sizes	Grandes tailles	De grandes dimensões	Grandes dimensiones
	Portrait	Verticale	Vertical	Vertical
	Landscape	Horizontale	Horizontal	Horizontal
	Portrait / Landscape	Vertical ou horizontale	Vertical ou horizontal	Vertical u Horizontal
	"Click" System	Système "Click"	Sistema "Click"	Sistema "Click"
	With Velcro	Avec velcro	Com Velcro	Con velcro
	Acrylic	Acrylique	Acrílico	Acrílico
	Economic	Économique	Económico	Económico
	Tools required	Outils nécessaire	Montagem com ferramentas	Requiere herramientas
	No tools required	Aucun outil requis	Montagem sem ferramentas	No requiere herramientas
QTY	Quantity	Quantité	Quantidade	Cantidad
NW	Net weight	Poids net	Peso líquido	Peso neto
GW	Gross weight	Poids brut	Peso bruto	Peso bruto
CBM	Cubic meter	Metres cubes	Metro cúbico	Metro cúbico
Size	Measures	Mesures.	Medidas	Medidas



X-Banner	4
L-Banner	6
Roll Up Banner	8
Mini Banner	28
Windows Banner	29
Cross Banner - Triple Banner	30
Bamboo Banner	31
Outdoor Banner	32
Beach Banner	41
Flying Banner	42
Indoor Flying Banner	44
Flying Banner Accessories	46
Backpack Banner	47
Exterior Solutions	48
Barrier Banner	56
Barrier Banner   Exhibition Wall	57
Fashion Pop Up	58
Velcro Pop Up	59
Pop Up	62
Display Accessories	71
TexFix	78
TexFix Light	85
TexFix Accessories	90
Canvas TexFix	92
Poster Display	93
Quick System	98
Promotion Counters	102
Carton Display	111
Carton Display Accessories	116
Poster System	124
Dispenser Displays	130
Giratorios	141

# X-Banner

X-Banner   

**EN** X-Banner is an interchangeable graphic system that can provide a large visual impact. Portable and detachable. Lightweight and easy to assemble. Carry bag is included.

**FR** Le X-Banner est un système de graphique interchangeable qui fournit un grand impact visuel. Portable, démontable, léger et facile à monter. Avec sac de transport inclus.

**PT** O X-Banner é um sistema que permite a mudança de imagem e que causa um grande impacto visual. Transportável, móvel, leve e fácil de montar. Inclui saco de transporte.

**ES** X-Banner, display ligero para gráficas intercambiables. Gran impacto visual. Es portátil y desmontable. Montaje rápido y sencillo. Incluye bolsa de transporte.

## Tudela



3 tamaños disponibles

Tudela	QTY	N.W	G.W	C.B.M.	Size
Packing	10	13.5kg	17.5kg	0.07	300x200x1080mm
Uni.	1	1.35kg	1.75kg	0.05	160x30x1080mm
10.007	Graphic Size: 600x1595mm				
Tudela	QTY	N.W	G.W	C.B.M.	Size
Packing	10	10.6kg	12.6kg	0.07	290x200x1210mm
Uni.	1	1.55kg	1.95kg	0.06	160x40x1210mm
10.111	Graphic Size: 600x1800mm				
Tudela	QTY	N.W	G.W	C.B.M.	Size
Packing	10	11.75kg	13.75kg	0.07	290x200x1210mm
Uni.	1	1.65kg	2.05kg	0.06	170x40x1210mm
10.112	Graphic Size: 800x1800mm				

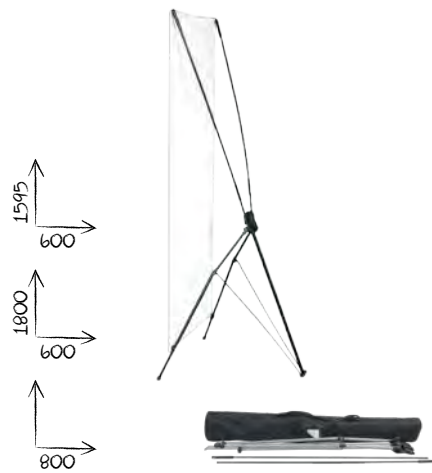

## Valoria

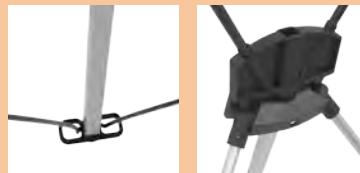

Valoria	QTY	N.W	G.W	C.B.M.	Size
Packing	10	17kg	19kg	0.08	300x200x1410mm
Uni.	1	1.70kg	1.90kg	0.008	200x30x1360mm
10.006	Graphic Size: 1200x1980mm				

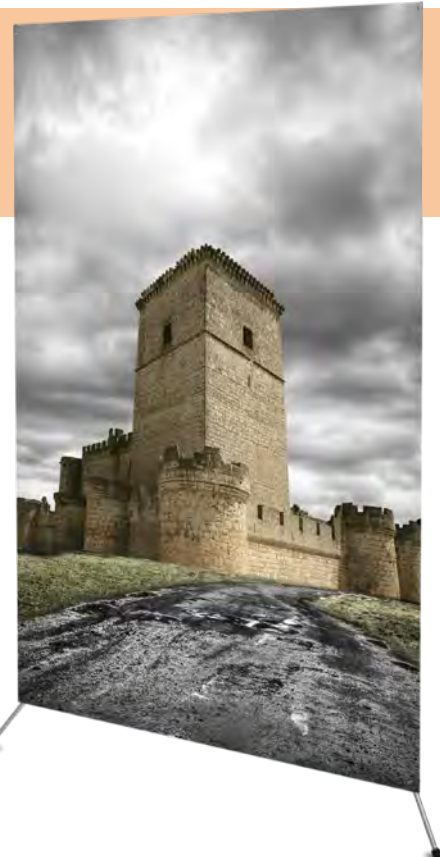

# X-Banner

Economic X-Banner



Lille  
Lyon  
Marseille



móntalo  
en pocos  
segundos



economic  
X-banner!



3 tamaños disponibles



Lille	QTY	N.W	G.W	C.B.M.	Size
Packing	65	19.5kg	22.7kg	0.17	400x400x1090mm
Uni.	1	0.30kg	0.35kg	0.009	140x60x1060mm
10.499	Graphic Size: 600x1600mm				



Lyon	QTY	N.W	G.W	C.B.M.	Size
Packing	60	21kg	24kg	0.17	400x400x1090mm
Uni.	1	0.35kg	0.40kg	0.009	140x60x1060mm
10.500	Graphic Size: 700x1800mm				



Marseille	QTY	N.W	G.W	C.B.M.	Size
Packing	50	20kg	22.5kg	0.19	400x400x1230mm
Uni.	1	0.40kg	0.45kg	0.01	140x60x1200mm
10.501	Graphic Size: 800x2000mm				



# L-Banner

L-Banner   

**EN** L-Banner is an easy interchangeable graphic system that can provide a large visual impact. Portable and detachable. Lightweight and easy to assemble. Carry bag is included.

**FR** Le L-Banner est un système de graphique interchangeable qui fournit un grand impact visuel. Portable, démontable, léger et facile à monter. Avec sac de transport inclus.

**PT** O L-Banner é um sistema que permite a mudança de imagem e que causa um grande impacto visual. Transportável, móvel, leve e fácil de montar. Inclui saco de transporte.

**ES** L-Banner, es un display ligero para gráficas intercambiables que causa un gran impacto visual. Es portátil y desmontable. Y su montaje es rápido y sencillo. Incluye bolsa de transporte.

## Mestanza

fácil de ensamblar

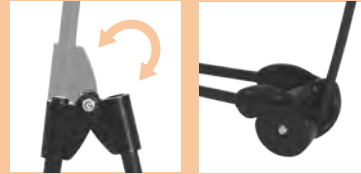

1600  
600

soporte publicitario portátil



Mestanza	QTY	N.W	G.W	C.B.M.	Size
Packing	25	10kg	11.25kg	0.073	300x230x1060mm
Uni.	1	0.40kg	0.45kg	0.004	140x30x1060mm
10.774	Graphic Size: 600x1600mm				

## Navas

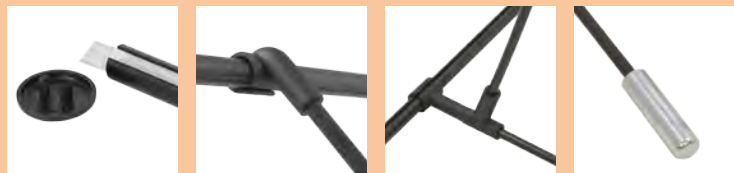

gráfica con tira adhesiva

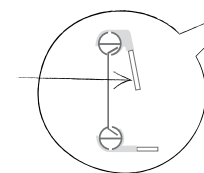

fácil de ensamblar

1840  
600

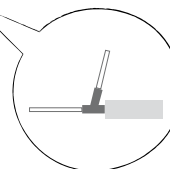

Navas	QTY	N.W	G.W	C.B.M.	Size
Packing	20	14kg	20kg	0.07	340x240x1000mm
Uni.	1	0.70kg	1kg	0.012	110x110x930mm
10.001	Graphic Size: 600x1840mm				

# L-Banner

L-Banner    

Sella

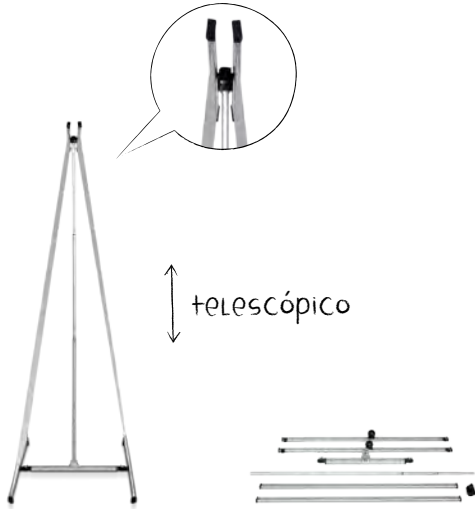

doble  
Cara

1800  
800



Sella	QTY	N.W	G.W	C.B.M.	Size
Packing	10	16.5kg	18kg	0.048	230x200x1050mm
Uni.	1	1.65kg	1.80kg	0.009	100x100x920mm

10.437 Graphic Size: 800x1800mm

Bonn

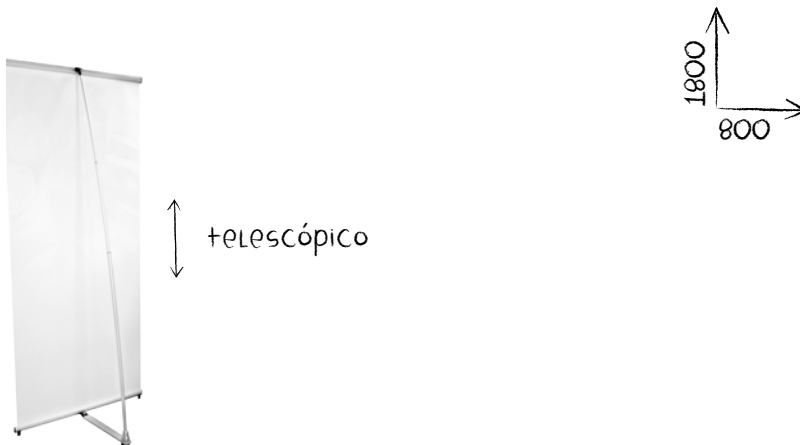
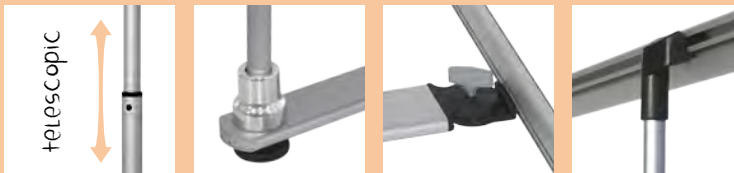

1800  
800



Bonn	QTY	N.W	G.W	C.B.M.	Size
Packing	10	12.5kg	14kg	0.048	230x200x1050mm
Uni.	1	1.25kg	1.40kg	0.0023	200x125x950mm

10.575 Graphic Size: 800x1800mm

# Roll Up Banner

Roll Up Banner  

**EN** Retractable banner stand. Installed within seconds. It's portable and detachable. Produced in anodized aluminium, plastic parts and others materials. Carry bag is included.

**FR** Enrouleur. L'assemblage peut être réalisé en quelques secondes. Fabriqué en différents types de matériaux (aluminium, plastique, etc). Léger et facile à monter. Sac de transport inclus.

**PT** Expositor retráctil. Monta-se em segundos sem necessidade de utilizar ferramentas e permite a mudança de imagem facilmente. Fabricado em diferentes materiais (aluminio, plástico, etc). Saco de transporte incluído.

**ES** Expositor enrollable para colocación de gráfica intercambiable. Portátil y desmontable. Fabricados en aluminio, plástico y otros materiales según modelo. Ligero y fácil de montar. Incluye bolsa de transporte.

## Abadia

3 sizes available

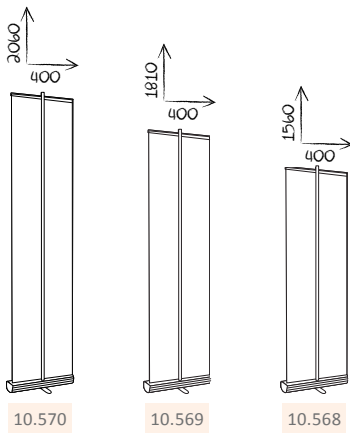

display ideal para columnas



Abadia	QTY	N.W	G.W	C.B.M.	Size
Packing	12	20.4kg	21.9kg	0.054	400x300x450mm
Uni.	1	1.43kg	1.53kg	0.004	95x95x430mm

10.570 Graphic: 400x2060mm

Abadia	QTY	N.W	G.W	C.B.M.	Size
Packing	12	19.2kg	20.7kg	0.054	400x300x450mm
Uni.	1	1.41kg	1.51kg	0.004	95x95x430mm

10.569 Graphic: 400x1810mm

Abadia	QTY	N.W	G.W	C.B.M.	Size
Packing	12	18kg	19.5kg	0.054	400x300x450mm
Uni.	1	1.35kg	1.45kg	0.004	95x95x430mm

10.568 Graphic: 400x1560mm

## Alzira

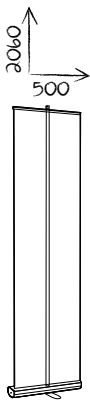

incluye bolsa transporte



## Albares

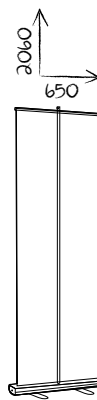

Alzira	QTY	N.W	G.W	C.B.M.	Size
Packing	6	9kg	10.2kg	0.05	340x240x580mm
Uni.	1	1.50kg	1.70kg	0.007	110x110x580mm

10.093 Graphic Size: 500x2060mm

Albares	QTY	N.W	G.W	C.B.M.	Size
Packing	6	9.60kg	10.6kg	0.06	340x240x730mm
Uni.	1	1.60kg	1.80kg	0.008	110x110x700mm

10.094 Graphic Size: 650x2060mm



# Roll Up Banner

Economic Roll Up Banner  

Alcala

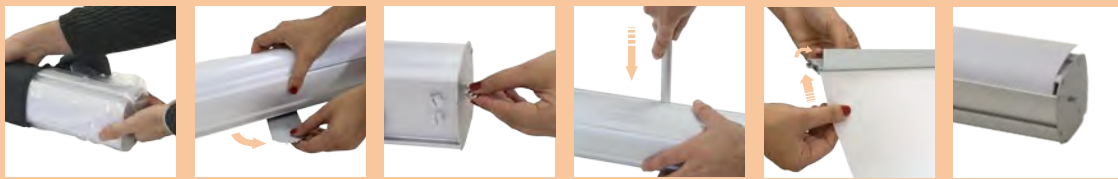

*economic roll up!*

2060  
850

**ECONOMIC**



*con pieza especial para estabilizar*

incluye bolsa transporte

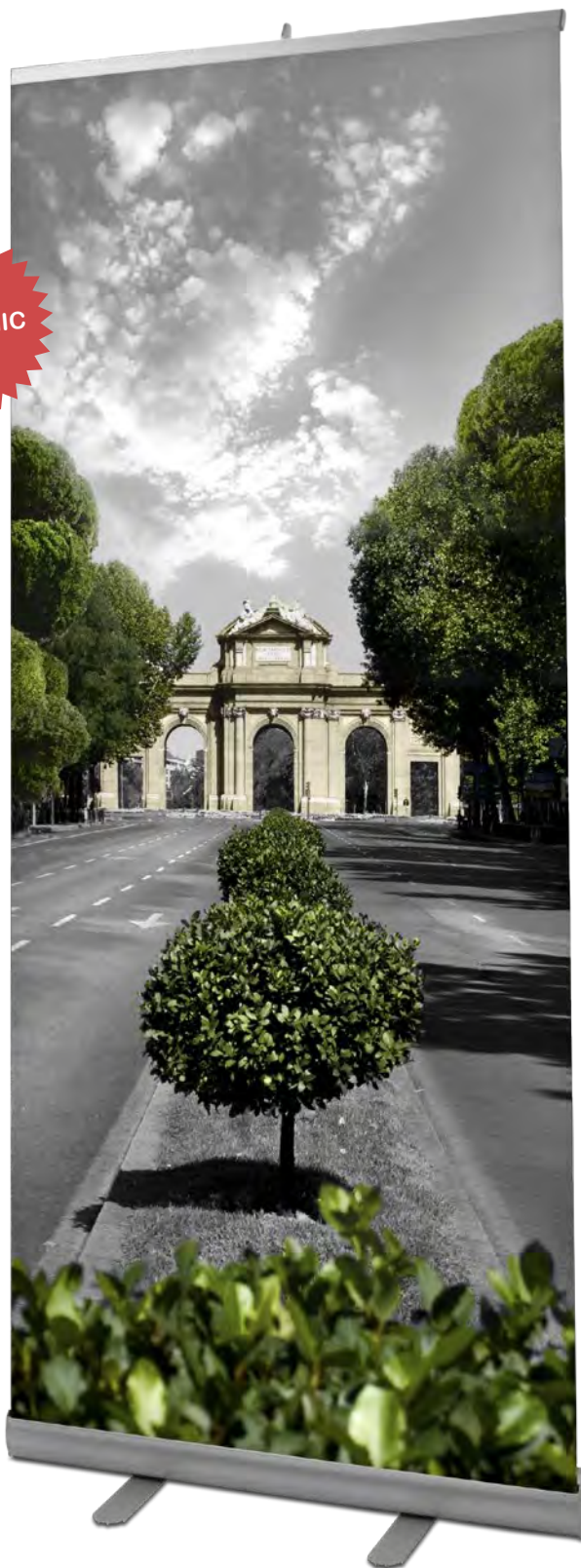

Alcala	QTY	N.W	G.W	C.B.M.	Size
Packing	10	20.93kg	21.41kg	0.08	475x200x900mm
Uni.	1	1.85kg	2.09kg	0.007	90x90x875mm
10.801		Graphic Size: 850x2060mm			

# Roll Up Banner

Economic Roll Up  

Alameda  
Aviles  
Ribadeo  
Navia

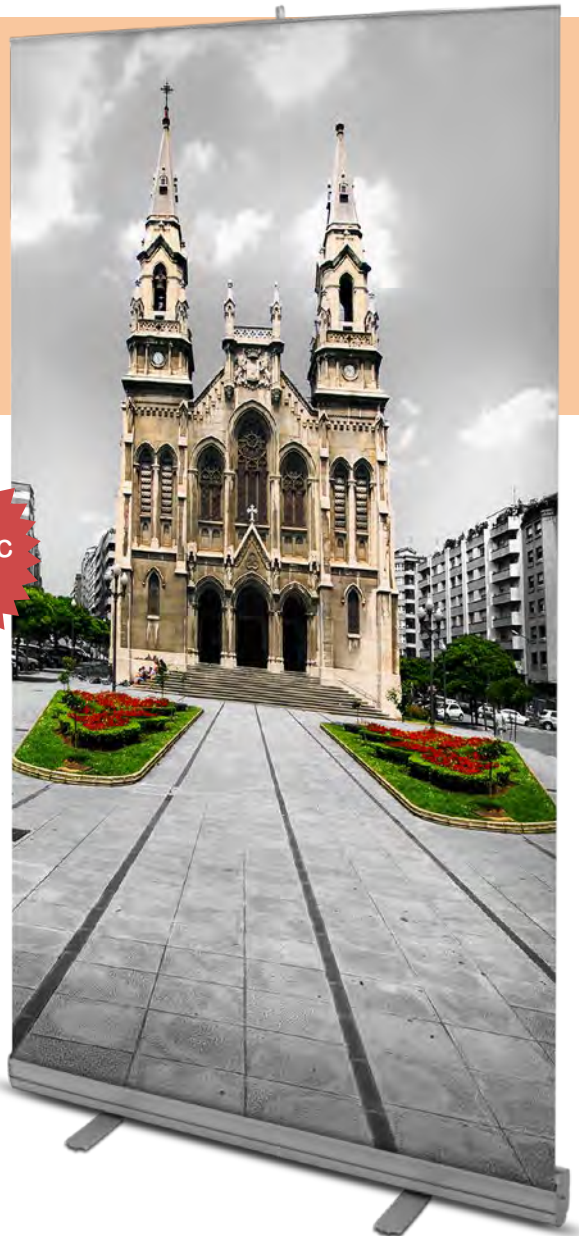

4 tamaños disponibles

**ECONOMIC**

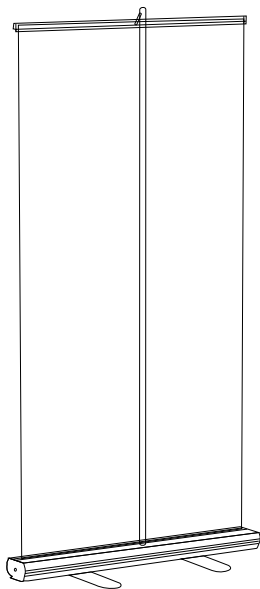

economic roll up



**NEW**



Alameda	QTY	N.W	G.W	C.B.M.	Size
Packing	6	10kg	14kg	0.06	310x210x860mm
Uni.	1	1.5kg	2.3kg	0.01	90x90x1040mm

10.401 Graphic Size: 800x2060mm



Ribadeo	QTY	N.W	G.W	C.B.M.	Size
Packing	6	15.30kg	16.5kg	0.078	300x200x1300mm
Uni.	1	2.55kg	2.75kg	0.012	95x95x1270mm

10.511 Graphic Size: 1250x2060mm



Aviles	QTY	N.W	G.W	C.B.M.	Size
Packing	10	20.8kg	22.1kg	0.063	480x200x1050mm
Uni.	1	2.08kg	2.21kg	0.01	90x90x1040mm

10.510 Graphic Size: 1000x2060mm



Navia	QTY	N.W	G.W	C.B.M.	Size
Packing	6	17.70kg	18.6kg	0.093	300x200x1550mm
Uni.	1	2.95kg	3.10kg	0.013	100x95x1520mm

10.512 Graphic Size: 1500x2060mm

# Roll Up Banner

Standard Roll Up



Alberca  
Alaraz  
Alhambra  
Almorox

set-up  
in a few  
seconds



4 tamaños  
disponibles



Alberca	QTY	N.W	G.W	C.B.M.	Size
Packing	6	12.60kg	14.40kg	0.07	320x230x910mm
Uni.	1	2.10kg	2.40kg	0.009	110x110x890mm
10.016	Graphic Size: 850x2060mm				
Alaraz	QTY	N.W	G.W	C.B.M.	Size
Packing	6	13.80kg	16.20kg	0.08	320x230x1070mm
Uni.	1	2.30kg	2.70kg	0.011	105x105x1040mm
10.365	Graphic Size: 1000x2060mm				
Alhambra	QTY	N.W	G.W	C.B.M.	Size
Packing	6	18kg	21kg	0.12	360x250x1320mm
Uni.	1	3kg	3.50kg	0.012	100x100x1290mm
10.900	Graphic Size: 1250x2060mm				
Almorox	QTY	N.W	G.W	C.B.M.	Size
Packing	6	19.8kg	22.8kg	0.109	320x220x1560mm
Uni.	1	3.30kg	3.80kg	0.018	110x110x1540mm
10.899	Graphic Size: 1500x2060mm				

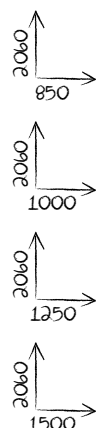

# Roll Up Banner

Large Roll Up   

## Almunia

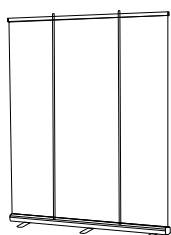

2060  
1750



Almunia	QTY	N.W	G.W	C.B.M.	Size
Packing	4	16kg	18.80kg	0.10	240x240x1810mm
Uni.	1	4kg	4.70kg	0.025	120x120x1785mm
10.095	Graphic Size: 1750x2060mm				

## Almansa

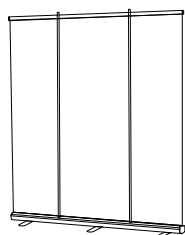

2060  
2000

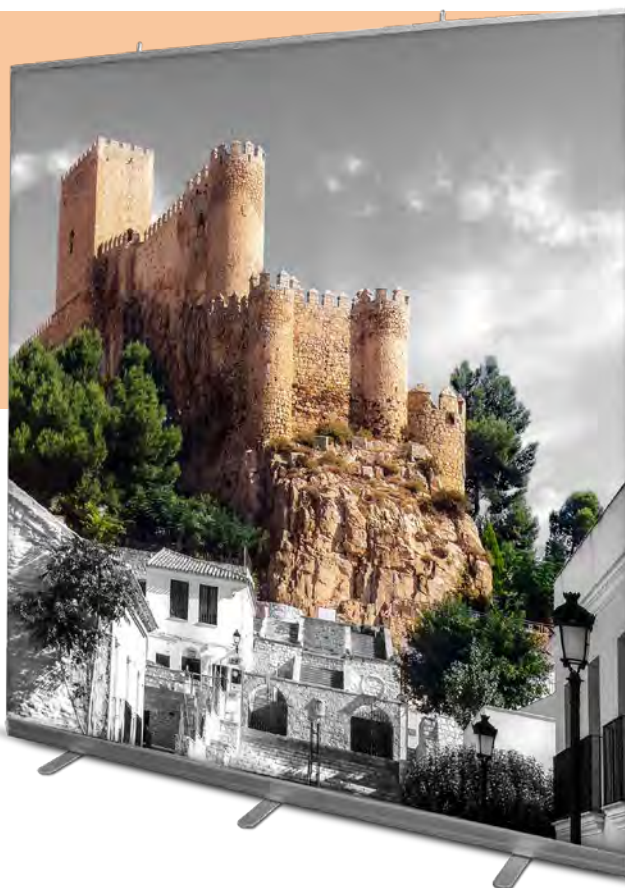

Almansa	QTY	N.W	G.W	C.B.M.	Size
Packing	4	16.80kg	19.60kg	0.11	240x240x2060mm
Uni.	1	4.20kg	4.90kg	0.020	100x100x2030mm
10.896	Graphic Size: 2000x2060mm				

# Roll Up Banner

Large Roll Up



Alpes

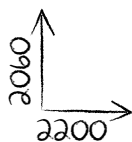
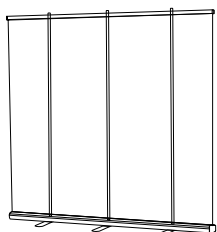

Alpes	QTY	N.W	G.W	C.B.M.	Size
Packing	4	19.2kg	23.2kg	0.132	240x240x2300mm
Uni.	1	4.8kg	5.8kg	0.032	120x120x2260mm

10.008 Graphic Size: 2200x2060mm

Alaska

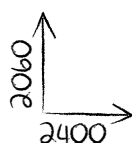
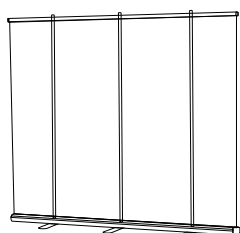

Alaska	QTY	N.W	G.W	C.B.M.	Size
Packing	1	8.10kg	9kg	0.048	140x140x2480mm

10.956 Graphic Size: 2400x2060mm

# Roll Up Banner

Black Colour Roll Up  

Altea

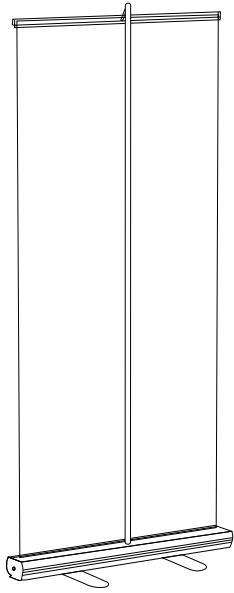
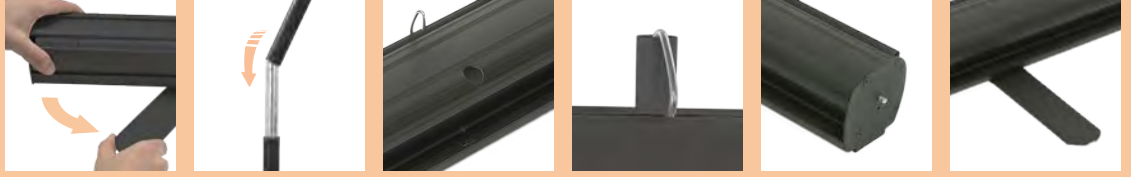

2 tamaños disponibles

Acabado en negro



Altea	QTY	N.W	G.W	C.B.M.	Size	
Packing	10	22kg	24kg	0.093	490x210x910mm	
Uni.	1	2.20kg	2.40kg	0.007	90x90x875mm	
10.680 Graphic Size: 850x2060mm						
Altea	QTY	N.W	G.W	C.B.M.	Size	
Packing	10	25kg	26kg	0.109	490x210x1060mm	
Uni.	1	2.50kg	2.60kg	0.011	105x105x1040mm	
10.681 Graphic Size: 1000x2060mm						

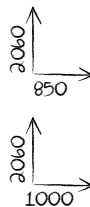

# Roll Up Banner

Standard Roll Up



Tablet Holder Roll Up

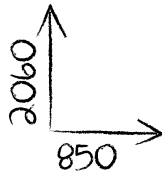
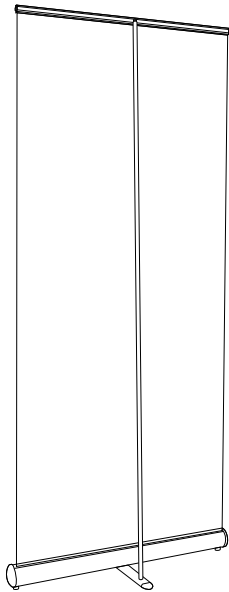

- seguro
- rota 360°
- 2 tamaños de tablet disponibles



(tablet no incluida)



Holder	QTY	N.W	G.W	C.B.M.	Size
Packing	1	0.75kg	0.90kg	0.003	260x47x310mm
		3.60kg	4.10kg	0.013	130x110x930mm
Graphic Size: 850x2060mm					
10.035	Safety Holder for Tablet: 185.8x241.3mm				
Holder	QTY	N.W	G.W	C.B.M.	Size
Packing	1	0.75kg	0.90kg	0.003	260x47x310mm
		3.60kg	4.10kg	0.013	130x110x930mm
Graphic Size: 850x2060mm					
10.053	Safety Holder for Tablet: 195.5x240mm				

# Roll Up Banner

Highly Resistant



Algeciras

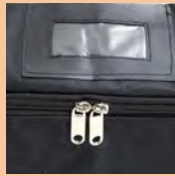

EN	Reinforced Steel.
FR	En acier renforcé.
PT	Aço reforçado.
ES	Reforzado en acero.



base reforzada

*¡Muy resistente!*

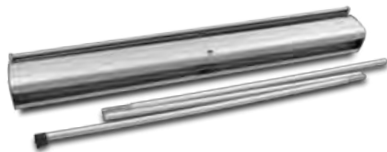
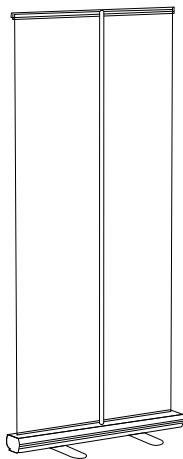

10.373

Algeciras	QTY	N.W	G.W	C.B.M.	Size
Packing	6	12.9kg	15kg	0.0464	320x220x675mm
Uni.	1	2.15kg	2.5kg	0.0109	125x130x660mm
<b>10.372</b>	<b>Graphic Size: 600x2060mm</b>				
Algeciras	QTY	N.W	G.W	C.B.M.	Size
Packing	6	17.1kg	19.2kg	0.0640	320x220x910mm
Uni.	1	2.85kg	3.20kg	0.0145	125x130x895mm
<b>10.373</b>	<b>Graphic Size: 850x2060mm</b>				
Algeciras	QTY	N.W	G.W	C.B.M.	Size
Packing	6	18kg	21kg	0.0746	320x220x1065mm
Uni.	1	3kg	3.5kg	0.0173	125x130x1050mm
<b>10.374</b>	<b>Graphic Size: 1000x2060mm</b>				



9 tamaños disponibles

Algeciras	QTY	N.W	G.W	C.B.M.	Size
Packing	4	15kg	17kg	0.1265	370x260x1315mm
Uni.	1	3.75kg	4.25kg	0.0213	125x130x1300mm
<b>10.038</b>	<b>Graphic Size: 1250x2060mm</b>				
Algeciras	QTY	N.W	G.W	C.B.M.	Size
Packing	4	18kg	20kg	0.1519	370x260x1580mm
Uni.	1	4.5kg	5kg	0.0256	125x130x1565mm
<b>10.039</b>	<b>Graphic Size: 1500x2060mm</b>				





# Roll Up Banner

Highly Resistant



Algeciras



EN	Reinforced Steel.
FR	En acier renforcé.
PT	Aço reforçado.
ES	Reforzado en acero.

¡Muy resistente!

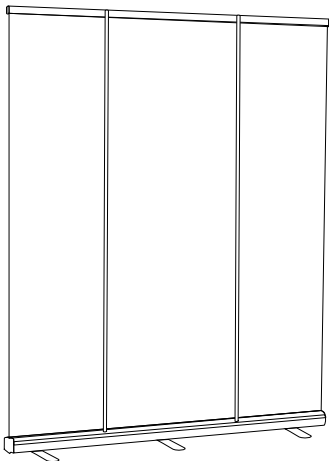

fácil y rápido de preparar



reforzado con acero



10.376

Algeciras	QTY	N.W	G.W	C.B.M.	Size
Packing	4	22kg	24kg	0.125	260x260x1850mm
Uni.	1	5.5kg	6kg	0.0307	130x130x1835mm
10.375	Graphic Size: 1750x2060mm				
Algeciras	QTY	N.W	G.W	C.B.M.	Size
Packing	4	26.4kg	28kg	0.0997	220x220x2060mm
Uni.	1	6.6kg	7kg	0.0343	130x130x2045mm
10.376	Graphic Size: 2000x2060mm				



Algeciras	QTY	N.W	G.W	C.B.M.	Size
Uni.	1	7.0	7.4	0.0353	125x125x2260mm
10.377	Graphic Size: 2200x2060mm				
Algeciras	QTY	N.W	G.W	C.B.M.	Size
Uni.	1	7.6	8	0.0384	125x125x2460mm
10.378	Graphic Size: 2400x2060mm				



# Roll Up Banner

Roll Up Lidine  

Lidine

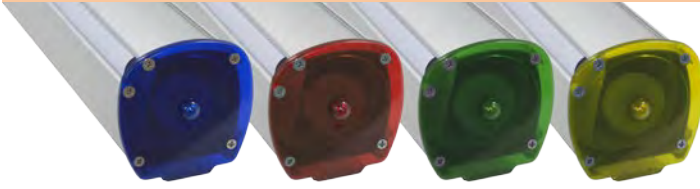
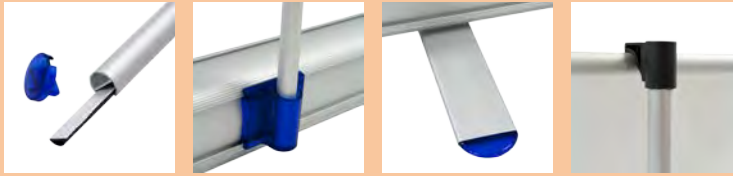

2060  
850

disponible en cuatro colores



Lidine	QTY	N.W	G.W	C.B.M.	Size
Packing	6	15kg	17kg	0.09	380x260x920mm
Uni.	1	2.5kg	2.83kg	0.009	110x100x890mm
10.660		Graphic Size: 850x2060mm			
10.661					
10.662					
10.663					

Dehesa

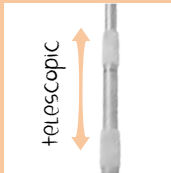

2260  
850

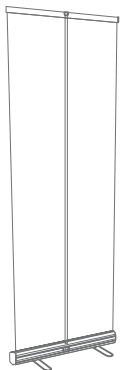

no requiere herramientas



Magnet Dispenser

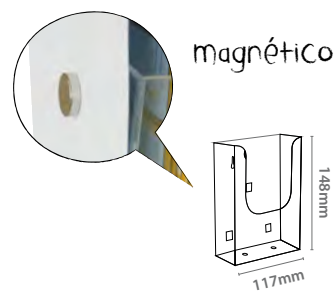

- EN Acrylic leaflet dispenser, in A6 size with double magnet.
- FR Support porte-brochures A6 avec double aimant.
- PT Porta-folhetos em acrílico para A6, com íman duplo.
- ES Soporte portacatálogos A6 con doble imán.



Dehesa	QTY	N.W	G.W	C.B.M.	Size
Packing	6	19.20kg	23kg	0.09	360x260x910mm
Uni.	1	3.15kg	3.50kg	0.01	110x110x900mm
10.020	Graphic Size: 850x2260mm				

Dispenser	QTY	N.W	G.W	C.B.M.	Size
Packing	5	0.85kg	0.95kg	0.004	165x130x215mm
10.860	Graphic Size: A6 x5 				

# Roll Up Banner

Roll Up Banner  

## Valdavia



no requiere herramientas

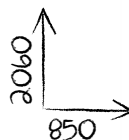

bolsa de transporte incluida



Valdavia	QTY	N.W	G.W	C.B.M.	Size
Packing	6	22.80kg	25.20 kg	0.07	320x230x910mm
Uni.	1	3.80kg	4.20kg	0.01	110x105x890mm
10.017		Graphic Size: 850x2060mm			

## Cervera

nivel pie



disponible en color gris o negro

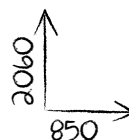

Cervera	QTY	N.W	G.W	C.B.M.	Size
Packing	4	18.2kg	23kg	0.16	530x300x980mm
Uni.	1	4.55kg	5.75kg	0.018	150x135x920mm
10.015		Graphic Size: 850x2060mm			

Cervera	QTY	N.W	G.W	C.B.M.	Size
Packing	4	18.2kg	23kg	0.16	530x300x980mm
Uni.	1	4.55kg	5.75kg	0.018	150x135x920mm
10.955		Graphic Size: 850x2060mm			

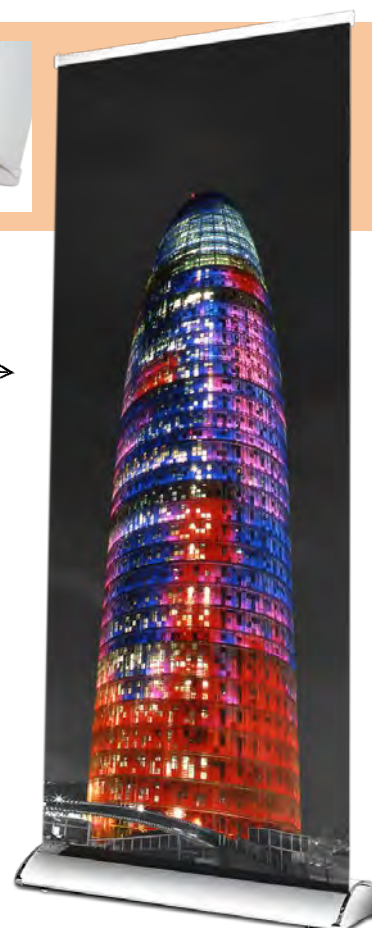

# Roll Up Banner

Roll Up Banner   

## Ribas



↑  
nivel pie

↑ 2060  
→ 850

↻  
doble  
Cara



Ribas	QTY	N.W	G.W	C.B.M.	Size
Packing	4	22kg	26.6kg	0.16	530x300x980mm
Uni.	1	5.5kg	6.65kg	0.03	250x135x920mm
10.013	Graphic Size: 850x2060mm				

## Fontiveros



4 tamaños disponibles

↻  
doble  
Cara

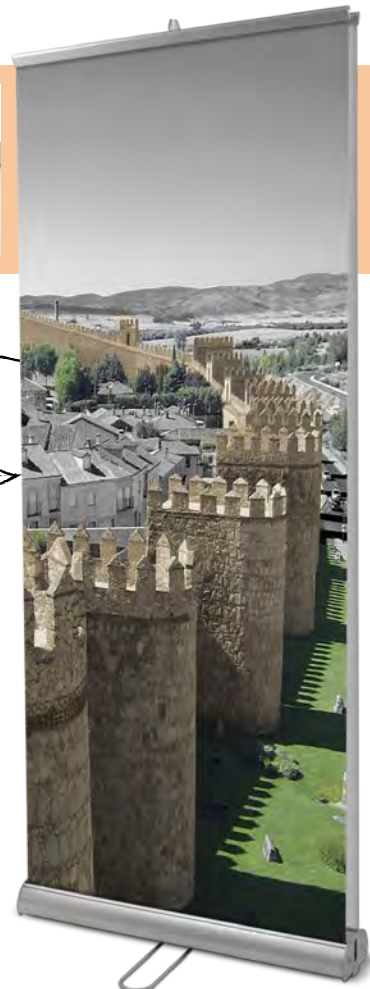

Fontiveros	QTY	N.W	G.W	C.B.M.	Size
Packing	3	13kg	15kg	0.06	350x190x930mm
Uni.	1	4.40kg	4.70kg	0.021	180x130x900mm
10.014	Graphic Size: 850x2060mm				
Fontiveros	QTY	N.W	G.W	C.B.M.	Size
Packing	3	15.60kg	16.80kg	0.07	350x190x1080mm
Uni.	1	5.20kg	5.60kg	0.024	180x130x1040mm
10.495	Graphic Size: 1000x2060mm				
Fontiveros	QTY	N.W	G.W	C.B.M.	Size
Packing	3	20.40kg	21.60kg	0.09	350x190x1280mm
Uni.	1	6.80kg	7.20kg	0.025	115x175x1280mm
10.496	Graphic Size: 1250x2060mm				
Fontiveros	QTY	N.W	G.W	C.B.M.	Size
Packing	3	24kg	25.20kg	0.11	350x190x1580mm
Uni.	1	8kg	8.40kg	0.033	180x120x1550mm
10.497	Graphic Size: 1500x2060mm				

↑ 2060  
→ 850

↑ 2060  
→ 1000

↑ 2060  
→ 1250

↑ 2060  
→ 1500

# Roll Up Banner

Roll Up Banner  

Asti

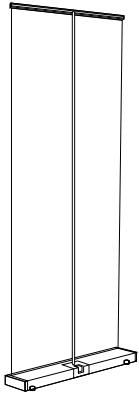
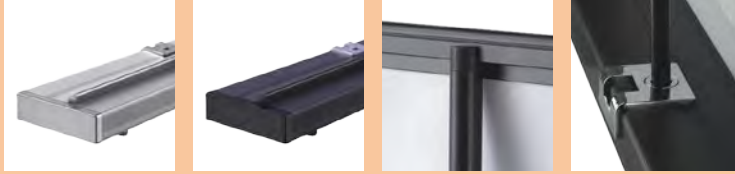

disponible en gris y negro

2060  
850



nivel pie

10.657

10.656

Asti	QTY	N.W	G.W	C.B.M.	Size
Packing	4	19.6kg	21kg	0.126	500x260x970mm
Uni.	1	4.90kg	5.20kg	0.018	150x135x920mm
10.657		Graphic Size: 850x2060mm			
10.656		Graphic Size: 850x2060mm			

Bremen



con mesa y porta Catálogos

2060  
905



EN	With wooden table and brochure holders included.				
FR	Avec tablette et porte-documents inclus.				
PT	Expositor retráctil com porta-folhetos e prateleira.				
ES	Con mesa de madera y portafolletos incluidos.				

Bremen	QTY	N.W	G.W	C.B.M.	Size
Packing	1	6.30kg	6.95kg	0.037	250x150x990mm
10.826	Graphic Size: 905x2060mm				

# Roll Up Banner

Large Roll Up   

XXL  
Everest



↑  
magnético c=

join it with other  
XXL Everest!

3060  
1200

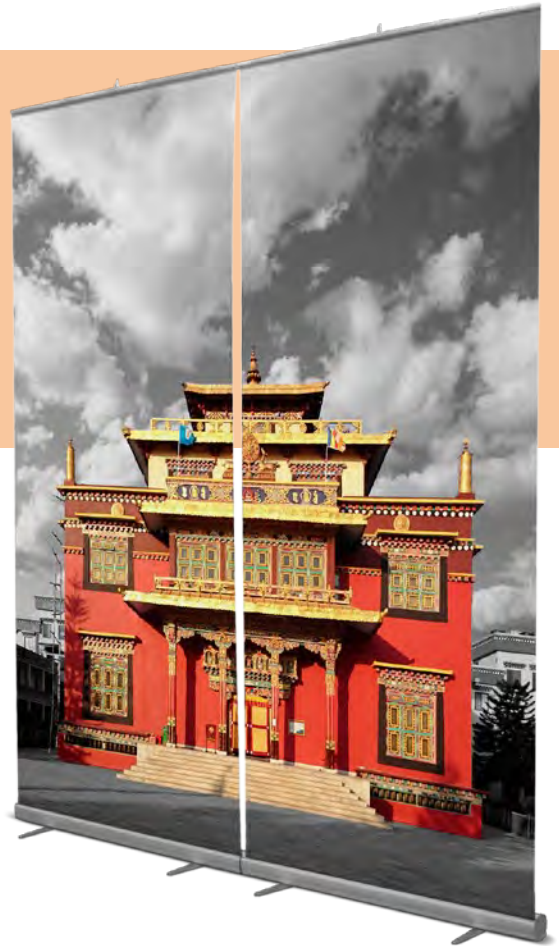

XXLEverest	QTY	N.W	G.W	C.B.M.	Size	
Packing	6	40.2kg	45kg	0.15	420x290x1260mm	
Uni.	1	6.50kg	7.30kg	0.018	120x120x1260mm	
10.861	Graphic Size: 1200x3060mm					

Valle



telescopico  
3060  
2000



Valle	QTY	N.W	G.W	C.B.M.	Size	
Packing	1	13.0kg	14.80kg	0.061	180x160x2120mm	
10.441	Graphic Size: 2000x3060mm					

# Roll Up Banner

Large Roll Up   

Max  
Elda  
Silver



2 tamaños disponibles

Max Elda S	QTY	N.W	G.W	C.B.M.	Size
Packing	2	21.2kg	26.6kg	0.189	320x230x2580mm
Uni.	1	10.6kg	13.30kg	0.071	320x90x2480mm
10.936	Graphic Size: 2400x2060mm				

Max Elda S	QTY	N.W	G.W	C.B.M.	Size
Packing	2	22.0kg	30.10kg	0.253	320x230x3440mm
Uni.	1	11.00kg	15.05kg	0.096	320x90x3340mm
10.937	Graphic Size: 3200x2060mm				

Max  
Elda  
Black



Color negro,  
2 tamaños disponibles

Max Elda B	QTY	N.W	G.W	C.B.M.	Size
Packing	2	21.2kg	26.6kg	0.189	320x230x2580mm
Uni.	1	10.6kg	13.30kg	0.071	320x90x2480mm
10.667	Graphic Size: 2400x2060mm				

Max Elda B	QTY	N.W	G.W	C.B.M.	Size
Packing	2	22.0kg	30.10kg	0.253	320x230x3440mm
Uni.	1	11.0kg	15.05kg	0.096	320x90x3340mm
10.668	Graphic Size: 3200x2060mm				

# Roll Up Banner

Outdoor Roll Up



Ibiza

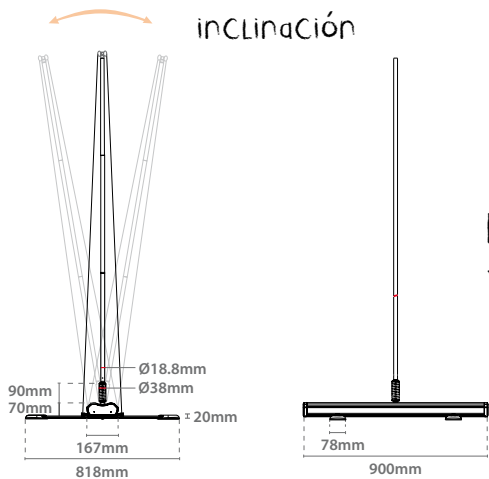

doble  
Cara

para interior  
y exterior

2060  
850



Ibiza	QTY	N.W	G.W	C.B.M.	Size
Packing	1	7.6kg	8.8kg	0.03	300x110x930mm
10.447	Graphic Size: 850x2060mm				

Ascoli

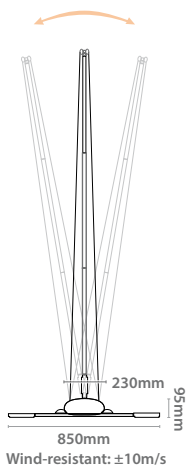
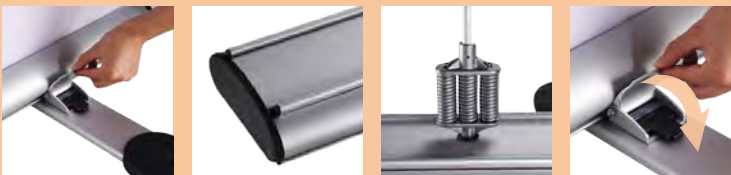

doble  
Cara

para interior  
y exterior

2060  
850



Ascoli	QTY	N.W	G.W	C.B.M.	Size
Packing	2	7.6kg	8.28kg	0.026	255x115x920mm
		5.8kg	6.4kg	0.021	170x140x920mm
10.655	Graphic Size: 850x2060mm				



# Roll Up Banner

LED Roll Up    

EN Roll Up Banner & accessories with LED System display. With multiple programmable modes via USB.  
FR Roll Up Banner et accessoires avec système de LED. Différentes programmations par clé USB.

PT Roll Up Banner e acessórios com sistema de visor LED. Diferentes programações facilmente por USB.  
ES Roll Up Banner y accesorios con sistemas de pantalla LED. Con múltiples modos programables mediante USB.

## LED Roll Up



scanea para descargar



Software Control LED

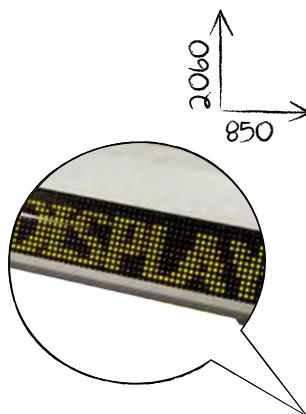

LED RollUp	QTY	N.W	G.W	C.B.M.	Size
Packing	1	5.55kg	6.0kg	0.031	245x135x940mm
13.477	Graphic Size: 850x2060mm				

## LED Support for Roll Up



Se programa por USB

Para Roll Up de 850 mm de ancho

Software Control LED



Support	QTY	N.W	G.W	C.B.M.	Size
Packing	1	0.55kg	0.70kg	0.007	90x90x900mm
13.478	Graphic Size: 850x50mm				

# Roll Up Banner

Scroll Roll Up    

EN Scrolling Roll Up Banner is electrically powered to make a real eye catching exhibition. Aluminium and plastic parts.  
FR Scrolling Roll Up Banner électrique en aluminium et plastique permettant la rotation "scroll" du visuel.

PT Roll Up Banner eléctrico de alumínio e plástico, para colocar no chão. Permite a colocação de uma imagem com efeito rotativo.  
ES Roll Up Banner eléctrico para suelo. Permite la colocación de una gráfica con efecto "scroll". Aluminio y partes de plástico.

## LED Scroll Banner

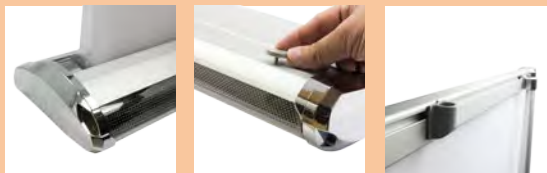

Banner LED banner + scroll eléctrico

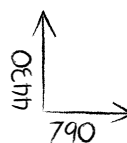

control del software

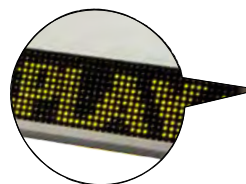

LED Scroll	QTY	N.W	G.W	C.B.M.	Size	
Packing	1	6.0kg	6.55kg	0.031	245x135x940mm	
13.479	Graphic Size: 790x4430mm					

## Pineda Scroll Banner

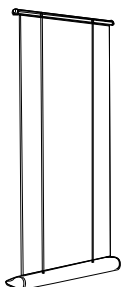

scroll eléctrico

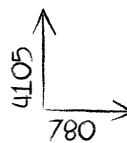

Pineda	QTY	N.W	G.W	C.B.M.	Size	
Packing	4	19.80kg	24.60kg	0.16	530x300x980mm	
Uni.	1	4.95kg	6.15kg	0.034	280x130x925mm	
10.022	Graphic Size: 780x4105mm					

# Roll Up Banner

Scroll | Mobile Banner  

## Aranda Scroll Banner



- EN Single sided electric banner for ceiling suspension. Made of aluminum and plastic parts.
- FR Banner électrique d'une seule face à suspendre au plafond. Fabriqué en aluminium et plastique.
- PT Banner eléctrico de alumínio e plástico de uma face para suspender do tecto.
- ES Banner eléctrico para suspensión a techo a una cara. Aluminio y partes de plástico.

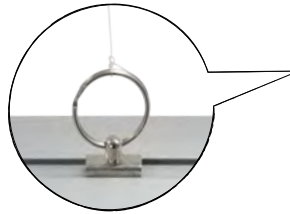



anilla para colgar



con interruptor



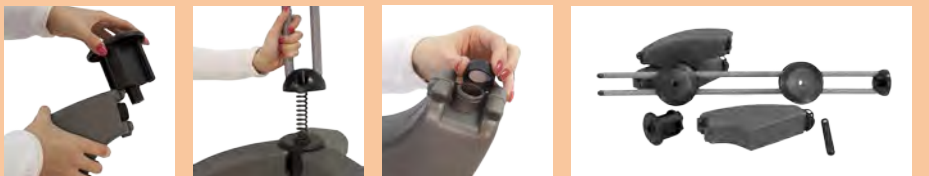

Aranda	QTY	N.W	G.W	C.B.M.	Size	
Packing	9	17.10kg	23.85kg	0.17	420x400x1000mm	 
Uni.	1	1.90kg	2.65kg	0.014	130x115x950mm	
10.023	Graphic Size: 800x3300mm					

## Marin Mobile Banner



con base de plástico rellenable

- EN Mobile Banner with fillable plastic water base for better stability. Ideal for fixing solid board. The graphic can be used on one or both sides.
- FR Banner mobile avec base en plastique à remplir d'eau, idéal pour la fixation de carton compact. Visuel double face.
- PT Expositor móvel com base de plástico que se pode encher com água. Ideal para a fixação de cartão compacto. Possibilidade de utilização em simples ou dupla face.
- ES Banner móvil con base de plástico rellenable de agua. Ideal para la fijación de cartón compacto. Uso a una o doble cara.

Marin	QTY	N.W	G.W	C.B.M.	Size	
Packing	1	2.10kg	2.65kg	0.03	310x85x1050mm	 
10.301	Graphic Size: 600-900x1200mm					

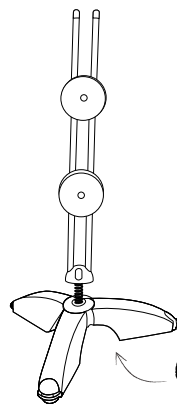

6kg of water

inclinación



# Mini Banner



## Mini Banner

EN Mini retractable desk banner stand.  
FR Mini enrouleur à présenter sur table.

PT Mini expositor retráctil para colocar sobre mesas.  
ES Sistema de colocación de gráficas de sobremesa.







### Torrigo Mini Roll Up



Torrigo A3	QTY	N.W	G.W	C.B.M.	Size	
Packing	24	9.60kg	12.20kg	0.041	370x300x370mm	
Uni.	1	0.40kg	0.45kg	0.0014	90x45x345mm	
10.786	Graphic Size: A3					
Torrigo A4	QTY	N.W	G.W	C.B.M.	Size	
Packing	24	8.4kg	9.60kg	0.03	300x280x370mm	
Uni.	1	0.35kg	0.40kg	0.001	90x45x260mm	
10.787	Graphic Size: A4					

### Daganzo LED writing Board



Daganzo A4	QTY	N.W	G.W	C.B.M.	Size	
Packing	20	13.0kg	26.0kg	0.09	480x360x540mm	  
Uni.	1	0.65kg	1.3kg	0.05	260x100x340mm	
10.307	Graphic Size: A4					
Daganzo A5	QTY	N.W	G.W	C.B.M.	Size	
Packing	40	7.6kg	15.6kg	0.1	440x420x530mm	  
Uni.	1	0.19kg	0.39kg	0.00	170x100x220mm	
10.308	Graphic Size: A5					

### Krakov Mini Flying Banner



Krakov	QTY	N.W	G.W	C.B.M.	Size	
Packing	1	0.30kg	0.35kg	0.0003	30x12x850mm	
10.596	Graphic Size: 550mm (Height)					

### Tordesillas Mini X-Banner



Tordesillas	QTY	N.W	G.W	C.B.M.	Size	
Packing	200	10kg	14kg	0.07	380x140x500mm	
Uni.	1	0.05kg	0.05kg	0.00045	45x35x285mm	
10.009	Graphic Size: 220x400mm					

# Windows Banner

Windows Banner 

EN Fixing system for graphics using suction cups.  
FR Système de fixation de visuel avec ventouse.

PT Sistema de colocação de imagens através de ventosas.  
ES Sistema de fijación de gráficas mediante ventosas.

## Vargas

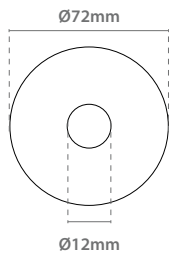

Vargas	QTY	N.W	G.W	C.B.M.	Size
Packing	12	0.4kg	0.45kg	0.04	580x170x40mm
10.798				x12	

## Cano

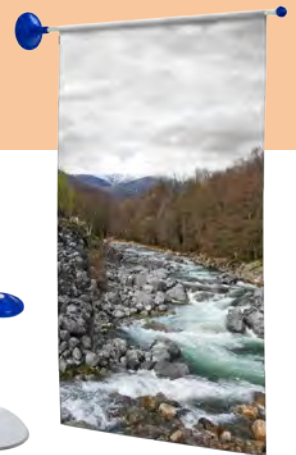

Cano	QTY	N.W	G.W	C.B.M.	Size
Packing	5	0.5kg	0.55kg	0.002	170x20x640mm
10.797				Graphic Size: 500x900mm	x5

## Gabin

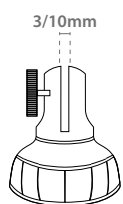

Gabin	QTY	N.W	G.W	C.B.M.	Size
Packing	1	0.25kg	0.3kg	0.001	125x125x125mm
10.595				Ø120mm	

## Viso

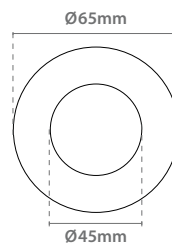

Viso	QTY	N.W	G.W	C.B.M.	Size
Packing	4	0.09kg	0.15kg	0.0008	120x80x80mm
10.779				x4	

# Cross Banner - Triple Banner

Cross Banner - Triple Banner  

EN Double sided or triple banner stand.  
Made of aluminium and plastic parts.  
FR Support visuel double/triple face.  
Fabriqué en aluminium et plastique.

PT Expositor de alumínio e plástico que permite  
a colocação de duas ou três impressões.  
ES Expositores para el empleo de dos o tres gráficas  
promocionales. Aluminio y partes de plástico.

## Tormes Cross Banner



doble  
Cara

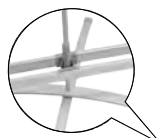

Tormes	QTY	N.W	G.W	C.B.M.	Size
Packing	10	14.50kg	18kg	0.08	340x240x980mm
Uni.	1	1.45kg	1.80kg	0.007	85x85x930mm

10.010 Graphic Size: 600x1700mm

## Almeida Cross Banner



doble  
Cara



Almeida	QTY	N.W	G.W	C.B.M.	Size
Packing	10	26kg	29kg	0.11	340x240x1280mm
Uni.	1	2.60kg	2.90kg	0.014	120x100x1170mm

10.708 Graphic Size: 1000x2000mm

## Galende Triple Banner



triple cara

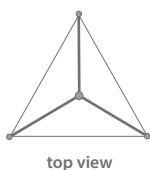
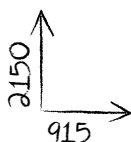

top view

Galende	QTY	N.W	G.W	C.B.M.	Size
Packing	5	14kg	16kg	0.017	400x150x1080mm
Uni.	1	2.65kg	3.05kg	0.02	160x160x650mm

10.012 Graphic Size: 915x2150mm

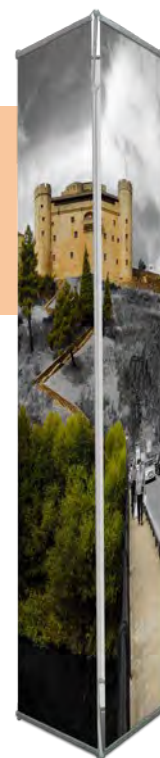
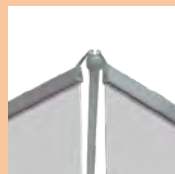

triple cara

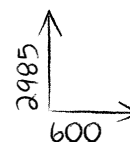

top view

Galende	QTY	N.W	G.W	C.B.M.	Size
Packing	5	25kg	26kg	0.11	310x210x1700mm
Uni.	1	3.35kg	4kg	0.02	120x120x1400mm

10.684 Graphic Size: 600x2985mm

# Bamboo Banner

Bamboo Banner  

**EN** Bamboo banner stand, allows an easy change of graphics. Stylish and functional design.  
**FR** Support visuel X-Banner, élégant et fonctionnel fabriqué en bambou. Léger et démontable.

**PT** Expositor em bambu que permite uma mudança rápida de imagem. Desenho elegante e funcional.  
**ES** Expositores ligeros y desmontables, fabricados en madera de Bambú. Elegante y funcional diseño.

## Bamboo X-Banner



eco friendly banner

2 tamaños disponibles

X-Bamboo	QTY	N.W	G.W	C.B.M.	Size
Packing	40	20kg	22.50kg	0.13	450x270x1130mm
Uni.	1	0.50kg	0.55kg	0.004	105x40x980mm
10.449	Graphic Size: 600x1600mm				
X-Bamboo	QTY	N.W	G.W	C.B.M.	Size
Packing	40	34kg	36kg	0.15	280x450x1180mm
Uni.	1	0.85kg	0.90kg	0.005	105x40x1100mm
10.450	Graphic Size: 800x1800mm				

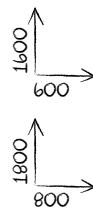

## Bamboo Roll Up



madera de bambú

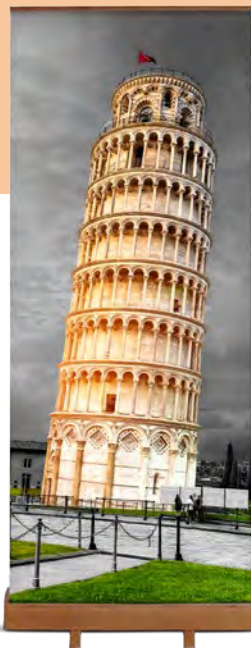
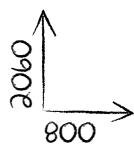

## Arbo



altura ajustable



Bamboo Roll	QTY	N.W	G.W	C.B.M.	Size
Packing	4	12.6kg	15.2kg	0.091	350x290x900mm
Uni.	1	3.15kg	3.80kg	0.02	170x140x870mm
10.444	Graphic Size: 800x2060mm				

Arbo	QTY	N.W	G.W	C.B.M.	Size
Packing	6	13kg	15kg	0.41	600x450x1550mm
Uni.	1	2.50kg	3.30kg	0.003	490x40x1425mm
10.452	Graphic Size: 400x1100mm				

# Outdoor Banner

Outdoor Banner 

**EN** Foldable banner, easy installation, ideal for indoor and outdoor events. Available in 3 sizes. Components:

- Carry bag.
- Hooks.
- Fiberglass pole connectors.
- Fiberglass pole.
- Black fabric of 60mm width.

**FR** Banner pliable, montage facile, idéal pour des événements d'intérieur ou d'extérieur. Disponible en trois dimensions. Inclus:

- Sac de transport.
- Crochets métalliques de fixation.
- Baguette en fibre.
- Connexion pour les baguettes en fibre.
- Textile noir de 60mm de large.

**PT** Expositor em tecido para exterior. Este sistema permite que uma só pessoa monte o expositor de forma fácil e rápida. Conteúdo:

- Bolsa de transporte.
- Ganchos metálicos para fixar.
- Uniões para as barras de fibra.
- Barras de fibra.
- Tela preta com 60mm para o rebordo.

**ES** Banner plegable de fácil montaje ideal para eventos tanto de interior como de exterior. Disponible en 3 tamaños. Componentes:

- Bolsa de transporte.
- Ganchos metálicos para clavar (piquetas).
- Conectores para los palos de fibra.
- Palos de fibra.
- Tela negra de 60mm de ancho de borde.

## Silves Golf Banner



se guarda rápido

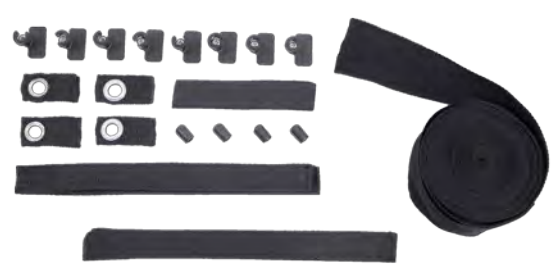
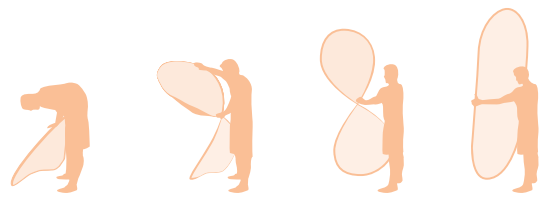

uso interior y exterior

Golf Banner	QTY	N.W	G.W	C.B.M.	Size
Packing	5	12.50kg	13kg	0.26	1200x180x1200mm
Uni.	1	2.50kg	2.60kg	0.05	1140x30x1140mm
10.426	Graphic Size: 1100x2700mm				
Golf Banner	QTY	N.W	G.W	C.B.M.	Size
Packing	5	8.50kg	8.9kg	0.17	960x180x960mm
Uni.	1	0.90kg	1kg	0.045	950x50x950mm
10.427	Graphic Size: 1000x2000mm				
Golf Banner	QTY	N.W	G.W	C.B.M.	Size
Packing	5	7kg	7.25kg	0.08	660x180x660mm
Uni.	1	1.40kg	1.45kg	0.012	640x30x640mm
10.428	Graphic Size: 620x1260mm				

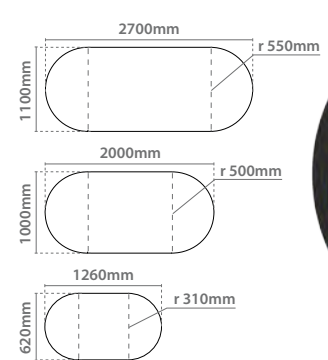



# Outdoor Banner

Outdoor Banner   

## Almazan



- EN X-Banner with large plastic base that can be filled with water. Fiberglass, aluminium.
- FR Support visuel en fibre de verre et aluminium avec base à remplir d'eau.
- PT Suporte tipo "X", com base de plástico que se pode encher com água, fabricado em fibra de vidro e alumínio lacado.
- ES Soporte tipo "X" con base de plástico rellenable de agua. Fabricado en fibra de vidrio, aluminio lacado y plástico.

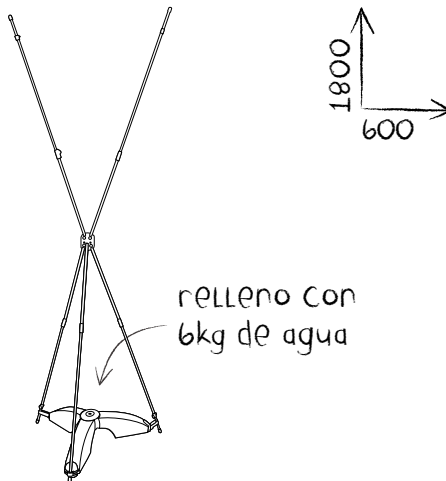

Almazan	QTY	N.W	G.W	C.B.M.	Size	
Pole	1	0.55kg	0.6kg	0.004	80x65x750mm	
Base	1	0.95kg	1kg	0.015	250x170x350mm	
10.028	Graphic Size: 600x1800mm					



## Almenar



- EN Y-Banner for promotional graphics, with plastic base that can be filled with water. Adjustable height. Fiberglass and aluminium.
- FR Support visuel, en forme de Y, ajustable en hauteur, fabriqué en fibre de verre et aluminium. Base en plastique à remplir d'eau.
- PT Y-Banner ajustável em altura para exterior com base que se pode encher com água. Fabricado em alumínio e fibra de vidro.
- ES Y-Banner regulable en altura. Con base de plástico rellenable de agua, varillas de fibra de vidrio y aluminio lacado.

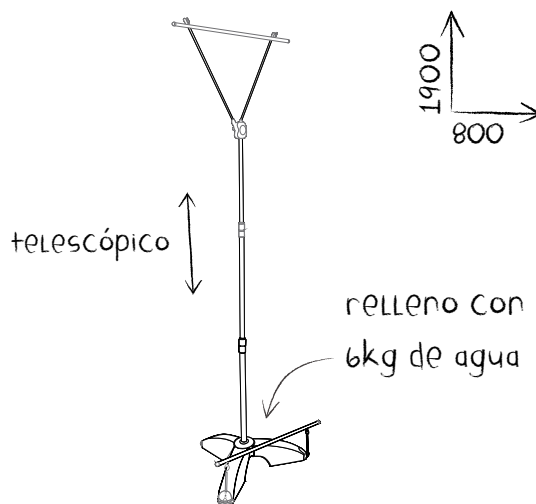

Almenar	QTY	N.W	G.W	C.B.M.	Size	
Packing	6	13kg	16.20kg	0.1	400x320x850mm	
Uni.	1	1.8kg	2.2kg	0.02	240x100x840mm	
10.029	Graphic Size: 800x1900mm					



# Outdoor Banner

Outdoor Banner   

## Haro



- EN Double-sided Outdoor Banner. Made of aluminum and refillable plastic base.
- FR Support visuel en aluminium, double face, avec base en plastique à remplir d'eau.
- PT Expositor retráctil de dupla face com base de plástico que se pode encher com água. Alumínio e plástico. Ideal para exterior.
- ES Banner de exterior doble cara. Realizado en aluminio y base de plástico rellenable.



relleno de 56kg de agua





con ruedas

2000  
800

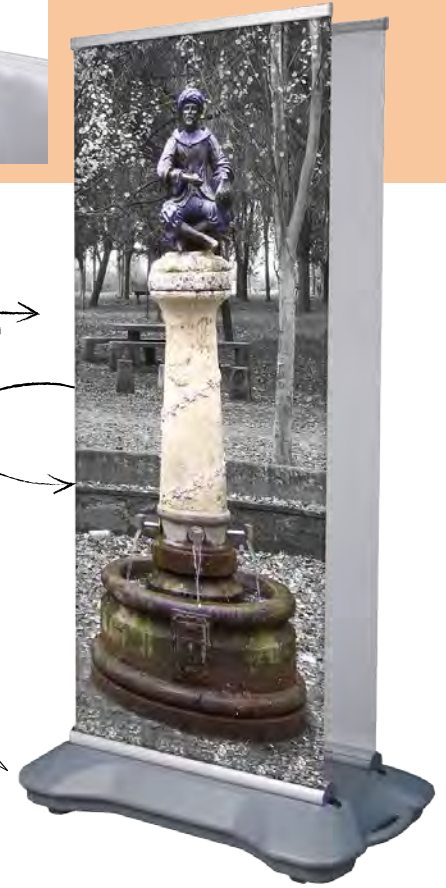
doble cara



Haro	QTY	N.W	G.W	C.B.M.	Size	
Packing	1	17.7kg	19.6kg	0.17	620x230x1160mm	 
10.954		Graphic Size: 800x2000mm				

## Medinaceli



- EN Banner with plastic base that can be filled with water. Aluminum and plastic parts.
- FR Exposeur avec base en plastique à remplir d'eau. Fabriqué en aluminium et plastique.
- PT Expositor com base de plástico que se pode encher de água. Fabricado em alumínio.
- ES Banner con base de plástico rellenable de agua y con varillas de aluminio.



interior y exterior



relleno con 12kg de agua

1600  
450



Medinaceli	QTY	N.W	G.W	C.B.M.	Size	
Packing	2	7kg	8.6kg	0.11	540x190x1050mm	
Uni.	1	2.85kg	3.50kg	0.05	500x100x1030mm	
10.026		Graphic Size: 450x1600mm				

# Outdoor Banner

Outdoor Banner   



Kiel



adjustable height

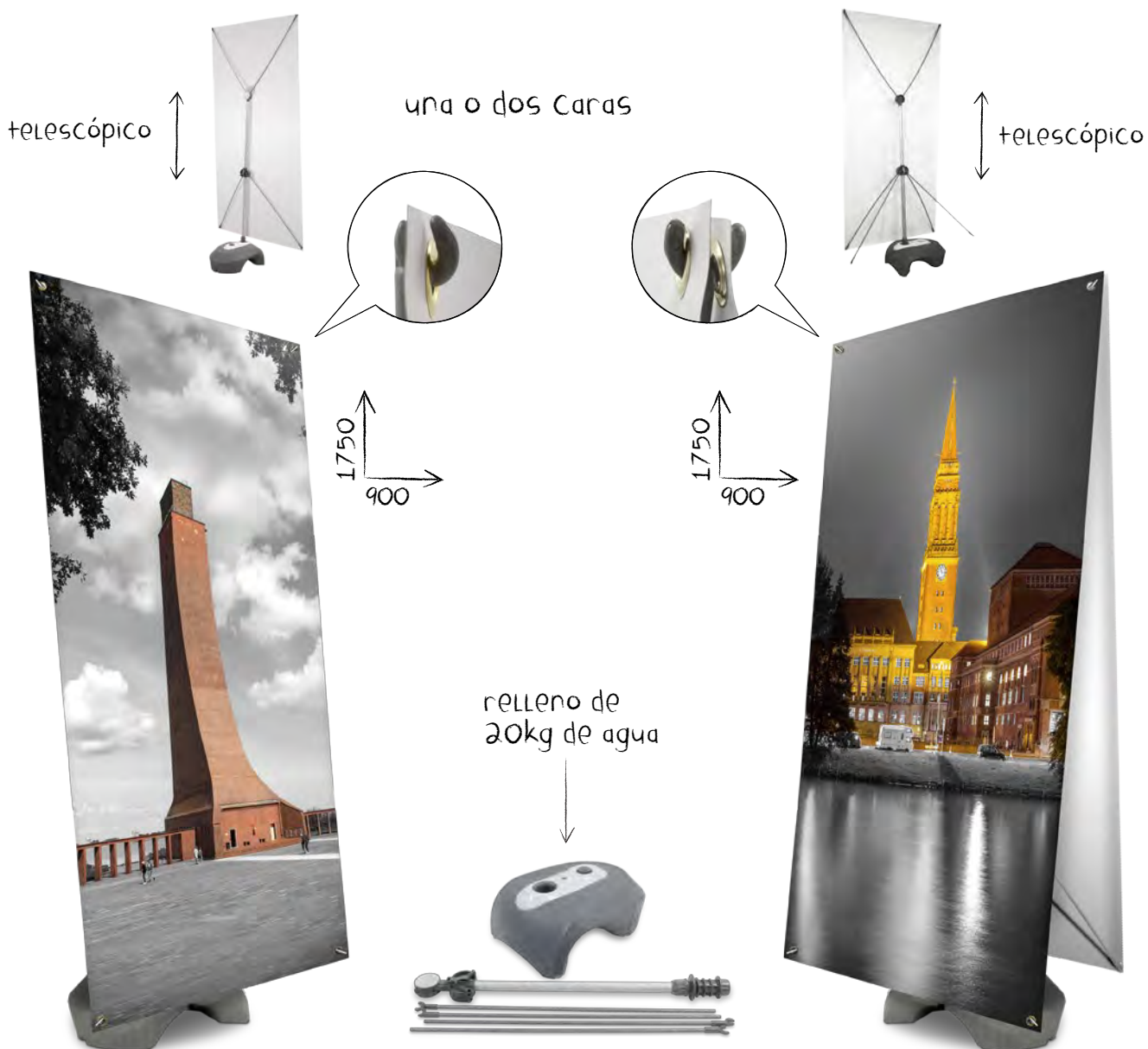

- EN Single or double sided water filled Banner. Telescopic support pole and the adjustable central hub allows the adjustment of height. Graphic area recommended: 900x1750mm. Aluminium, plastic parts.
- FR Support visuel en aluminium, ajustable en hauteur, idéal pour l'extérieur. Base en plastique à remplir d'eau. Disponible en simple et double face. Format du visuel recommandé: 900x1750mm.
- PT Expositor de simples ou dupla face com base que se pode encher com água. Possui um mastro central ajustável em altura. Área de impressão recomendada: 900x1750 mm.
- ES Banner de exterior para gráfica promocional. Realizado en aluminio y con base de plástico rellenable. Ajustable en altura. Disponible para 1 o 2 caras. El Área gráfica recomendada es: 900x1750mm.



Kiel	QTY	N.W	G.W	C.B.M.	Size	
Packing	1	2.8kg	3.25kg	0.09	400x200x1080mm	 
10.573	Graphic Size: 900x1750mm					

Kiel (Double)	QTY	N.W	G.W	C.B.M.	Size	
Packing	1	3kg	3.45kg	0.09	400x200x1080mm	 
10.574	Graphic Size: 900x1750mm					

# Outdoor Banner

Outdoor Banner   

## Charleroi



382  
330



- EN Banner ideal for outdoor use like shop entrances, gardens, sidewalks, etc. Double-sided. Base fillable with water or sand.
- FR Banner double face avec base à remplir d'eau ou de sable. Idéal pour une utilisation à l'extérieur.
- PT Expositor dupla face em plástico. A sua base enche-se com água/ areia. Ideal para colocar em parques, entradas de lojas e passeios.
- ES Banner de exterior ideal para uso en entradas de tiendas, jardines, aceras, etc. Doble cara. Base rellenable de agua o arena.

Charleroi	QTY	N.W	G.W	C.B.M.	Size	
Packing	1	2kg	2.5kg	0.07	500x200x690mm	
10.248	Graphic Size: 330x382mm					



1200mm  
doble  
Cara

relleno con 4kg de arena o agua



## Ocean

**NEW**

ideal for indoor or outdoor use

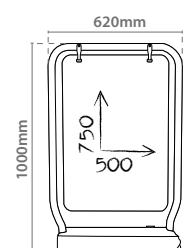

con panel oscilante



doble  
Cara

relleno con 10 kg de arena o agua



Ocean	QTY	N.W	G.W	C.B.M.	Size	
Uni.	1	5.4kg	7.0kg	0.17	1100x140x1100mm	
10.305	Graphic Size: 500x750mm					

## Delta



ideal para uso interior o exterior

700  
550

Delta	QTY	N.W	G.W	C.B.M.	Size	
Packing	1	7kg	8kg	0.05	630x80x1010mm	
10.679	Graphic Size: 550x700mm					



doble  
Cara

# Outdoor Banner

Flagpoles    

Yuste





Brest

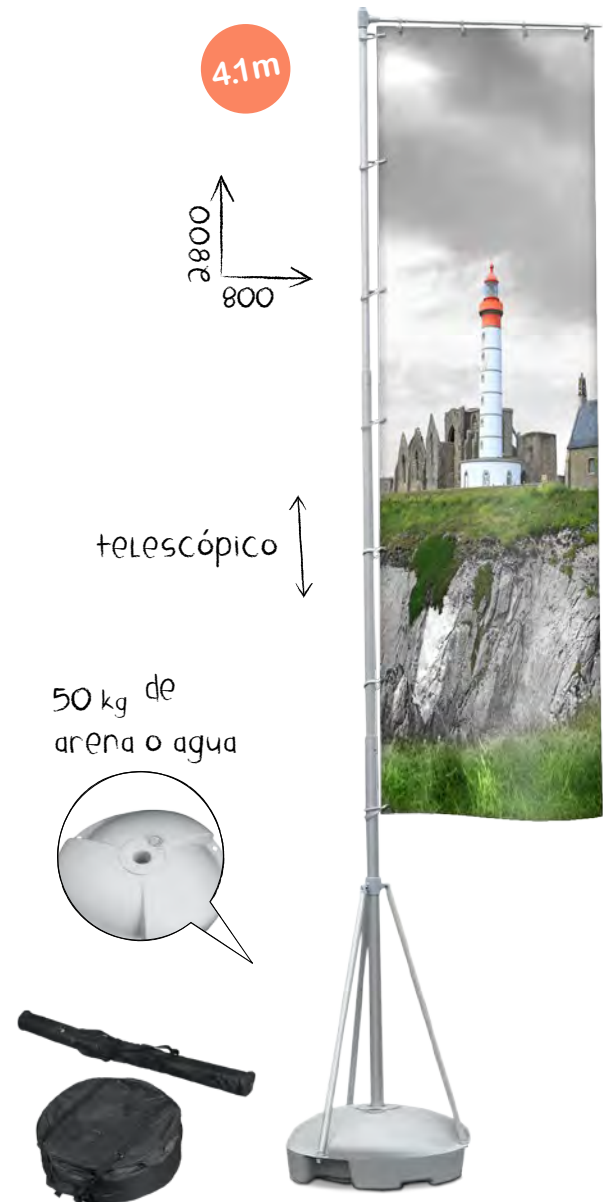

EN	Outdoor flagpole. Can be used with two graphics. Water filled stand. Aluminium, plastic parts. Visible at a great distance.
FR	Banderole extérieure en aluminium et base en plastique remplissable d'eau. Permet la visualisation des images à grande distance.
PT	Mastro de exterior para a colocação de duas imagens. Possui uma base onde se pode colocar água. Fabricado em alumínio e plástico.
ES	Banderola de exterior para dos gráficas promocionales. Realizado en aluminio y con base de plástico. Gráfica visible a gran distancia.

EN	Giant flagpole 4,1 meters high. Delivery with a heavy plastic foot which can be filled with 50kg of sand/water.
FR	Banderole extérieure télescopique. Base en plastique remplissable d'eau. Facile à monter. Hauteur de 4,1m.
PT	Mastro de grandes dimensões. Possui uma base de 50kg de água/areia. Fabricado em alumínio e plástico. Altura 4,1m.
ES	Bandera para exteriores con base de plástico rellenable. Expositor telescópico y de fácil montaje. Altura 4,1m.



Yuste	QTY	N.W	G.W	C.B.M.	Size	
Pole	1	1.35kg	1.85kg	0.015	120x80x1650mm	
Base	1	0.95kg	1.15kg	0.017	260x200x340mm	 
10.709	Graphic Size: 600x1500/4500mm					

Brest	QTY	N.W	G.W	C.B.M.	Size	
Pole	1	4.1kg	5.1kg	0.029	135x135x1610mm	
Base	1	6kg	6.3kg	0.117	665x265x665mm	
10.652	Graphic Size: 800x2800mm					

# Outdoor Banner

Flagpoles



Cergy



EN

Giant flagpole of 7 or 9 meters high. Delivery with a heavy plastic foot which can be filled with sand or water. Aluminium, plastic parts.

FR

Mât de grande dimension pour drapeau, fabriqué en aluminium et plastique. Hauteur disponible en 7 ou 9 mètres. Possède une base, lourde, à remplir d'eau ou de sable.

PT

Mastros de grandes dimensões: 7 ou 9 metros. Possuem uma base onde se pode colocar água. Em alumínio e plástico.

ES

Bandera para exteriores con base rellenable y soportes de plástico para la gráfica. Expositor plegable y telescópico fabricado en aluminio.



7m

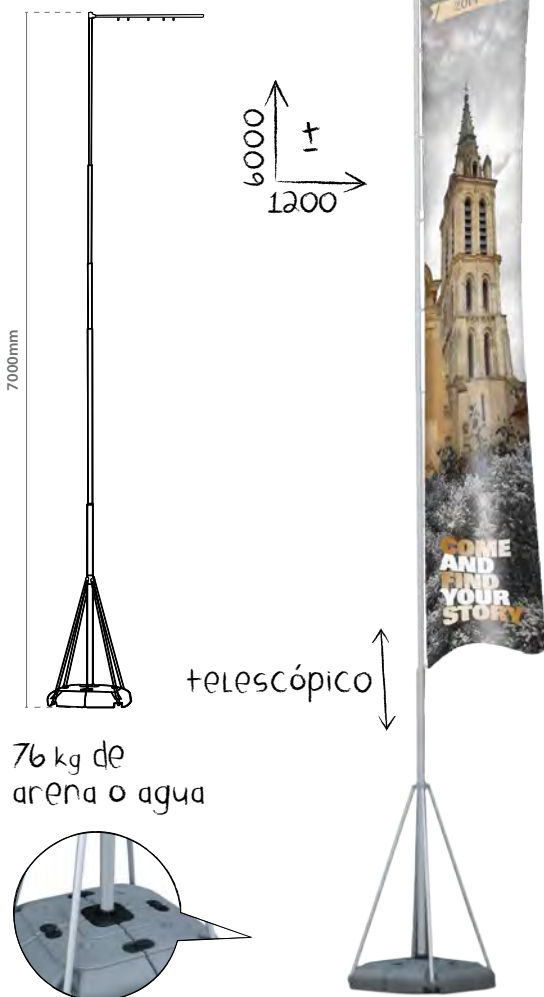

9m

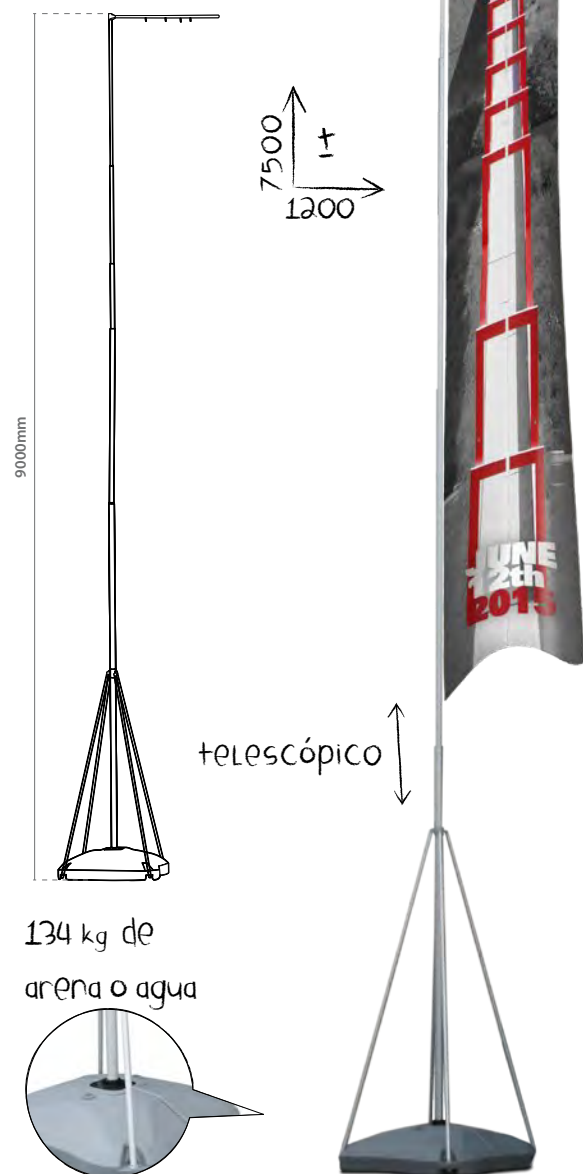

Cergy 7m	QTY	N.W	G.W	C.B.M.	Size	
Pole	1	6.5kg	7.5kg	0.03	150x130x1710mm	
Base	1	8kg	9kg	0.13	410x410x805mm	
10.577	Graphic Size: ± 1200x6000mm					

Cergy 9m	QTY	N.W	G.W	C.B.M.	Size	
Pole	1	8.5kg	9.5kg	0.05	180x170x1710mm	
Base	1	14kg	15kg	0.24	510x510x920mm	
10.578	Graphic Size: ± 1200x7500mm					

# Outdoor Banner

Flagpoles    

Bejar



EN

Giant flagpole of 5 meters high. Delivery with a plastic foot which can be filled with 76 liters of sand or water. Telescopic banner, includes plastic clips for bottom graphics. Aluminium, plastic parts.

FR

Mât de grande dimension pour drapeau, fabriqué en aluminium et plastique. Disponible en hauteur de 5 mètres. Possède une base avec une capacité de 76 litres.

PT

Mastro de grandes dimensões: 5 metros. Possuem uma base onde se pode colocar água ou areia (76 kg). Expositor dobrável e telescópico. Em alumínio e plástico.

ES

Bandera para exteriores con base de plástico rellenable de agua o arena (76kg). Varillas de aluminio con soportes de plástico para la gráfica. Expositor plegable y telescópico.

exterior / interior

5m

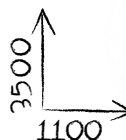
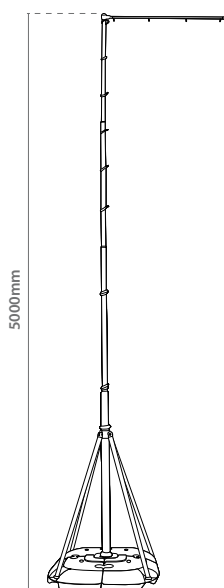

telescópico



76 kg de  
agua o arena



Bejar	QTY	N.W	G.W	C.B.M.	Size	
Pole	1	7.5kg	9.8kg	0.04	160x130x1680mm	
Base	1	10kg	11kg	0.14	430x380x850mm	
10.031	Graphic Size: 1100x3500mm					

# Outdoor Banner

Outdoor Banner

**EN** Outdoor banner stand with water/sand fillable base offering impressive single or double-sided graphic displays. Aluminium, plastic parts.  
**FR** Banner double face équipé de réservoir Fabriqu  en aluminium satin  et plastique.

**PT** Banner de exterior com reservat rios na base que se podem encher com  gua ou areia. Oferece um grande impacto visual tanto em simples como em wedupla face.  
**ES** Banner de exterior con bases rellenables, fabricado en aluminio satinado y pl stico. A doble cara.

## Barahona 1

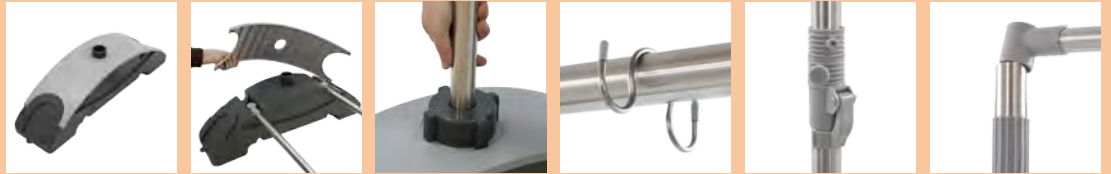

relleno con 25kg de agua o arena

doble cara

2000  
2500

Barahona 1	QTY	N.W	G.W	C.B.M.	Size
Pole	1	11.5kg	16kg	0.04	410x210x1660mm
Base	1	8kg	9kg	0.11	430x310x850mm
10.030	Graphic Size: 2500x2000mm				

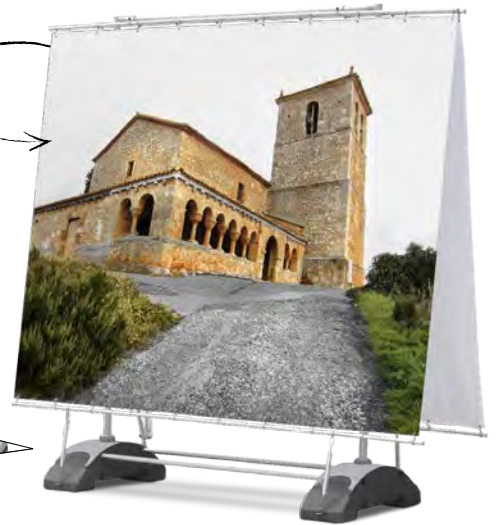

## Barahona 2



doble cara

2450  
5640

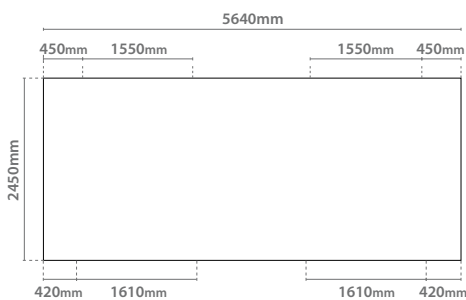

Barahona 2	QTY	N.W	G.W	C.B.M.	Size
Pole	1	17.2kg	21.1kg	0.044	170x150x1720mm
Base	1	13.30kg	18.3kg	0.12	470x300x850mm
10.830	Graphic Size: 5640x2450mm				

relleno con 25kg de agua o arena





# Beach Banner

Beach Banner   

Square

3 sizes available



múltiple combinaciones con los accesorios

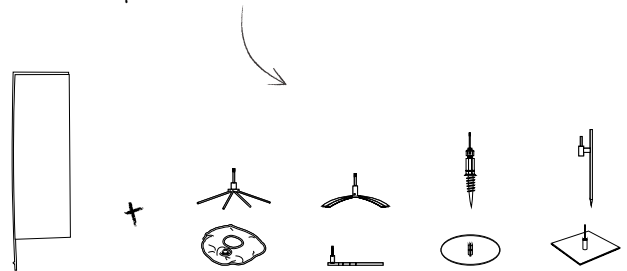

..... external size  
- - - - - graphic size

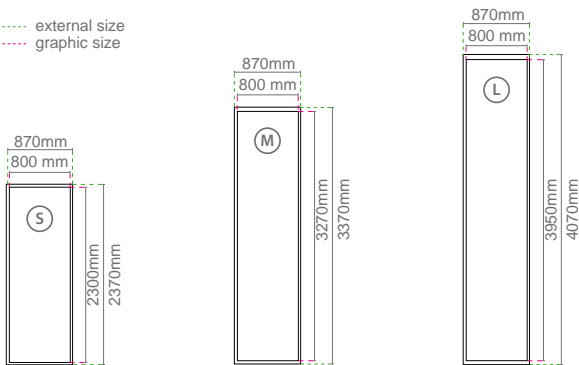

13.608

13.609

13.610



Square S	QTY	N.W	G.W	C.B.M.	Size
Packing	1	0.94kg	1.44kg	0.004	80x50x1050mm
13.608				(S)	
Square M	QTY	N.W	G.W	C.B.M.	Size
Packing	1	1.46kg	1.96kg	0.005	100x50x1050mm
13.609				(M)	
Square L	QTY	N.W	G.W	C.B.M.	Size
Packing	1	1.80kg	2.30kg	0.005	100x50x1050mm
13.610				(L)	

# Flying Banner

Flying Banner   

**EN** Flying Banner. Available in 4 different sizes. You can choose different flying banner base feet. Aluminium, fiber glass and plastic parts. The price includes only the pole.

**FR** Mât en aluminium, fibre de verre et plastique pour drapeaux. Disponible en 4 tailles différentes. Possibilité de choisir parmi plusieurs socles. Prix du mât.

**PT** Mastro para exterior disponível em 4 tamanhos e que se adapta a diferentes bases. Fabricado em alumínio, fibra de vidro e plástico. Preço do mastro.

**ES** Flying Banner. Disponible en 4 medidas. Puede combinarse con distintos tipos de bases. Fabricado en aluminio, fibra de vidrio y partes plásticas. Precio solo del poste.

Spoon

4 sizes available

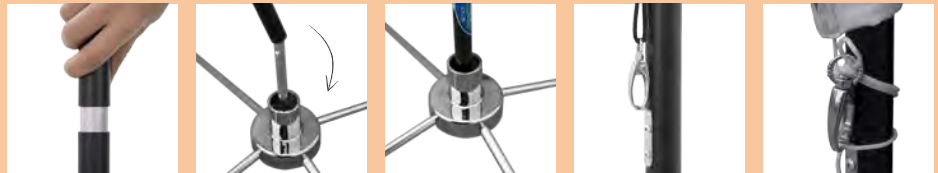

múltiple combinaciones con los accesorios

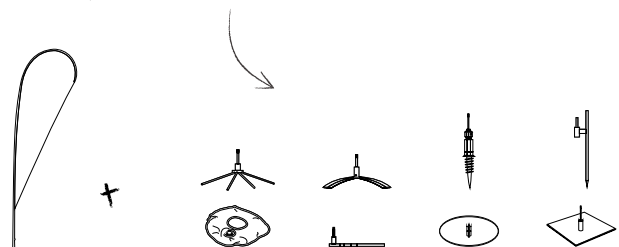

--- external size  
- - - graphic size

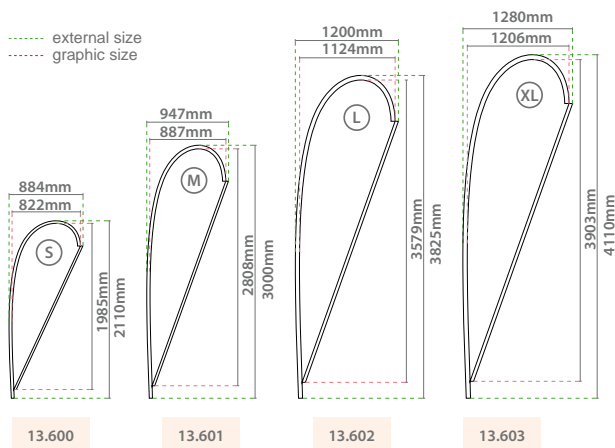

Spoon S	QTY	N.W	G.W	C.B.M.	Size
Packing	1	0.67kg	0.72kg	0.004	65x50x1410mm
13.600				(S)	
Spoon M	QTY	N.W	G.W	C.B.M.	Size
Packing	1	1.07kg	1.57kg	0.005	80x50x1410mm
13.601				(M)	
Spoon L	QTY	N.W	G.W	C.B.M.	Size
Packing	1	1.49kg	1.99kg	0.005	80x50x1410mm
13.602				(L)	
Spoon XL	QTY	N.W	G.W	C.B.M.	Size
Packing	1	1.78kg	2.28kg	0.005	80x50x1410mm
13.603				(XL)	



# Flying Banner

Flying Banner   

Knife

4 sizes available



múltiple combinaciones con los accesorios

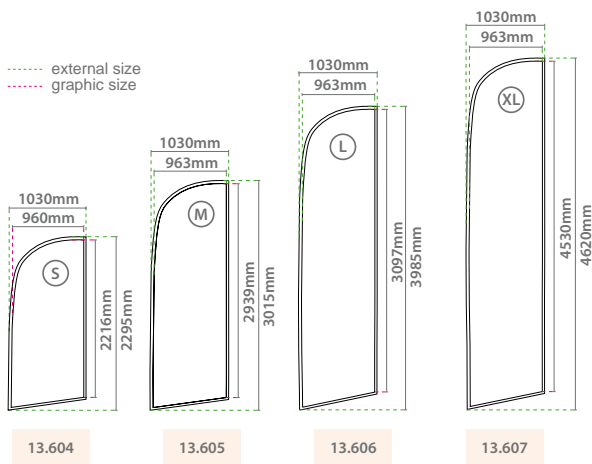
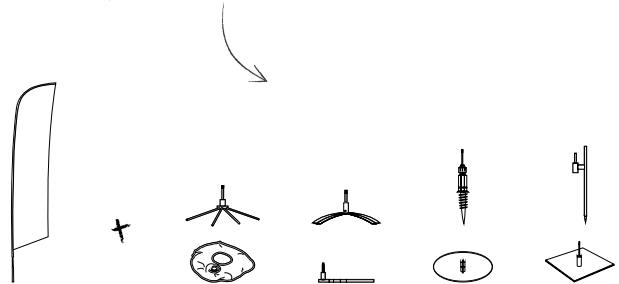

13.604

13.605

13.606

13.607

Knife S	QTY	N.W	G.W	C.B.M.	Size
Packing	1	0.94kg	1.44kg	0.005	80x50x1410mm
13.604				(S)	
Knife M	QTY	N.W	G.W	C.B.M.	Size
Packing	1	1.15kg	1.65kg	0.005	80x50x1410mm
13.605				(M)	
Knife L	QTY	N.W	G.W	C.B.M.	Size
Packing	1	1.60kg	2.10kg	0.005	80x50x1410mm
13.606				(L)	
Knife XL	QTY	N.W	G.W	C.B.M.	Size
Packing	1	1.65kg	2.15kg	0.006	90x50x1410mm
13.607				(XL)	

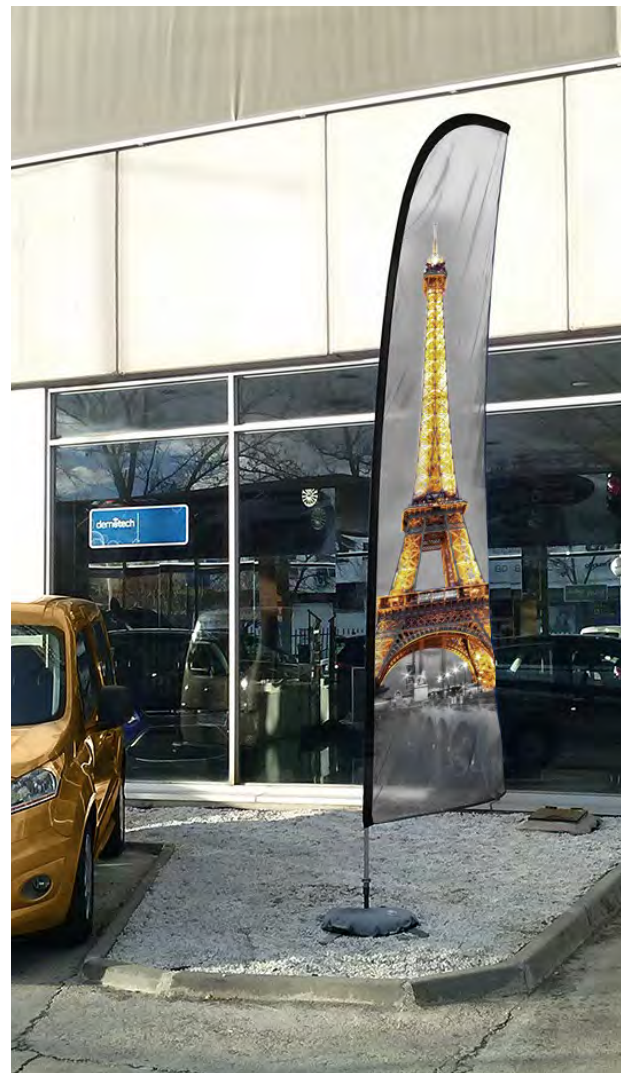

# Indoor Flying Banner

Indoor Flying Banner  

**NEW**

**EN** Indoor Flying Banner, 6 different models available. You can choose a flying banner base feet covered with an anti-scratch soft velvet finish. The price includes only the pole.  
**FR** Drapeaux d'intérieure disponible en six modèles différents. Possibilité d'être utilisé un socle avec finition anti-rayures . Prix seulement du mât.

**PT** Bandeira para interior disponível em seis modelos diferentes. Pode utilizá-lo com uma base revestida para evitar arranhões. Preço somente para o mastro.  
**ES** Flying Banner de interior. Seis modelos diferentes disponibles. Puede combinarse con una base antideslizante provista de revestimiento anti-arañazos. El precio incluye sólo el poste.

## Teardrop

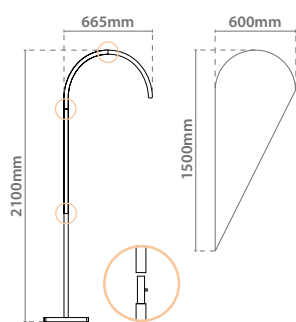
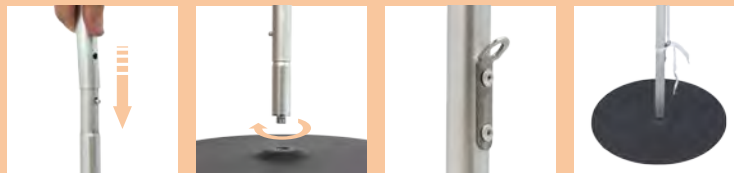

Combine it with indoor round base!

Teardrop	QTY	N.W	G.W	C.B.M.	Size
Packing	1	0.50kg	0.65kg	0.0087	145x60x1000mm
13.621	Graphic Size: 605x1455mm				

## Feather

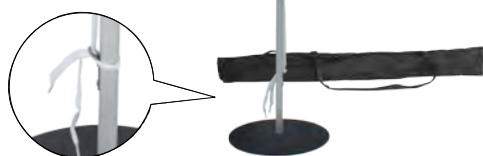
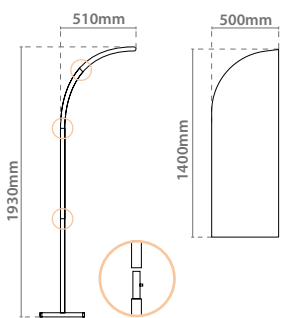

Feather	QTY	N.W	G.W	C.B.M.	Size
Packing	1	0.40kg	0.55kg	0.0087	145x60x1000mm
13.622	Graphic Size: 480x1380mm				

## Squared

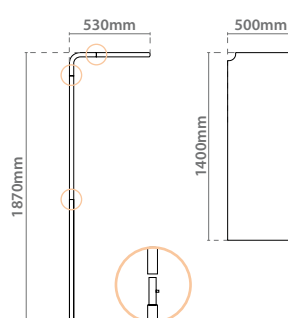

Squared	QTY	N.W	G.W	C.B.M.	Size
Packing	1	0.40kg	0.55kg	0.0087	145x60x1000mm
13.623	Graphic Size: 500x1375mm				

# Indoor Flying Banner

Indoor Flying Banner  

## Senator

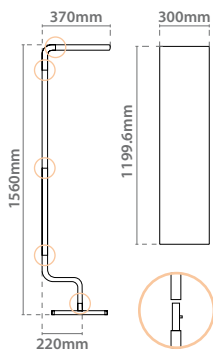
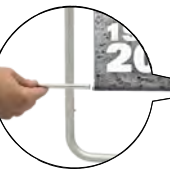

Senator	QTY	N.W	G.W	C.B.M.	Size
Packing	1	0.45kg	0.60kg	0.0087	145x60x1000mm
13.624	Graphic Size: 290x1150mm				

## Razor

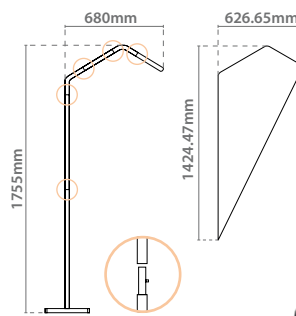

Razor	QTY	N.W	G.W	C.B.M.	Size
Packing	1	0.45kg	0.60kg	0.0087	145x60x1000mm
13.625	Graphic Size: 630x1410mm				

## Kite

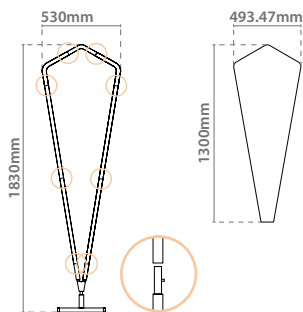
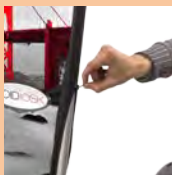

Kite	QTY	N.W	G.W	C.B.M.	Size
Packing	1	0.85kg	1.0kg	0.0087	145x60x1000mm
13.626	Graphic Size: 475x1240mm				

## Indoor Round Base

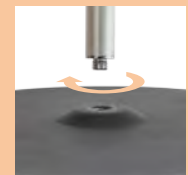

realizado en metal



Round Base	QTY	N.W	G.W	C.B.M.	Size
Packing	1	1.10kg	1.20kg	0.00198	315x20x315mm
13.627	Diameter: Ø 300mm				

# Flying Banner Accessories

Flying Banner Accessories

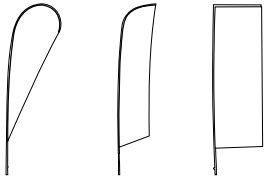

+

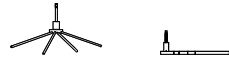

## Cross Base with Water Plastic Bag

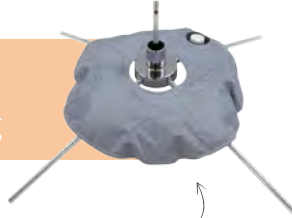

3kg agua

Cross Base	QTY	N.W	G.W	C.B.M.	Size
Packing	40	28kg	31kg	0.115	620x460x720mm
Uni.	1	0.7kg	0.77kg	0.025	350x110x590mm
13.611					

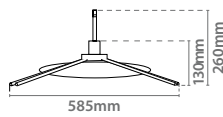

## Tire Base U Style

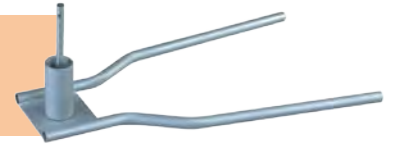

Tire Base	QTY	N.W	G.W	C.B.M.	Size
Packing	20	34kg	37kg	0.138	540x400x640mm
Uni.	1	1.7kg	1.85kg	0.028	380x120x620mm
13.614					

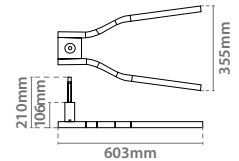

## Water Plastic Bag



relleno con 3kg agua

Plast Bag	QTY	N.W	G.W	C.B.M.	Size
Packing	20	3kg	4kg	0.006	200x150x200mm
Uni.	1	0.15kg	0.2kg	0.009	140x40x160mm
10.766					

## Round Plate Base

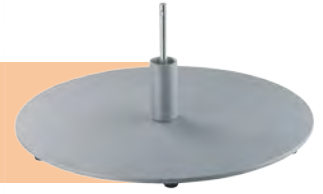

Round Base	QTY	N.W	G.W	C.B.M.	Size
Packing	1	11.3kg	11.8kg	0.014	530x45x590mm
13.615					

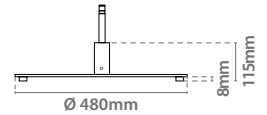

## Ground Drill



Ground Drill	QTY	N.W	G.W	C.B.M.	Size
Packing	20	12kg	15kg	0.115	460x410x610mm
Uni.	1	0.6kg	0.75kg	0.025	390x110x590mm
13.612					

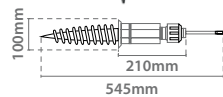

## Square Plate Base



Square Base	QTY	N.W	G.W	C.B.M.	Size
Packing	1	13.8kg	14.3kg	0.014	530x45x590mm
13.616					

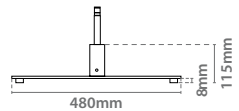

## Round Straight Spike

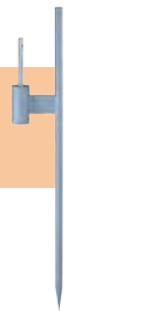

Round Spike	QTY	N.W	G.W	C.B.M.	Size
Packing	20	30kg	33kg	0.061	300x225x610mm
Uni.	1	1.5kg	1.65kg	0.009	55x40x590mm
13.613					

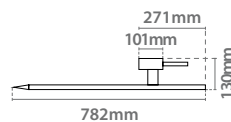

## Cross Plate Base

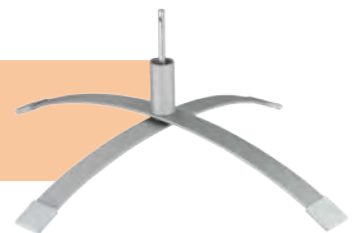
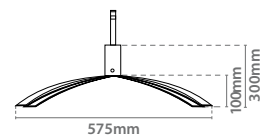

Plate Cross	QTY	N.W	G.W	C.B.M.	Size
Packing	5	21.5kg	24kg	0.030	320x120x800mm
Uni.	1	4.3kg	4.8kg	0.005	110x60x780mm
13.617					



# Backpack Banner

Flag Backpack Banner | X-Backpack Banner



EN	Promotional system composed by a lightweight and comfortable bagpack and an exhibition structure. Ideal for conventions, exhibitions, or streetmarketing. Supplied with Carry bag.
FR	Système portable pour publicité qui comprend un sac à dos confortable et super léger avec une structure publicitaire. Préconisé pour des salons, convections ou streetmarketing. Inclus sac de transport.
PT	Sistema transportável para propaganda, composto por uma mochila confortável e muito leve e uma estrutura publicitária. É ideal para feiras, convenções ou streetmarketing. Inclui a bolsa de transporte.
ES	Sistema de promoción portatil compuesto por una mochila ultraligera y confortable y una estructura publicitaria, ideal para ferias, convenciones o streetmarketing. Incluye la bolsa de transporte.

## X-Backpack Backpack

NEW

Ligero y  
confortable



todos los backpacks  
incluyen:

bolsillo superior



bolsillos  
laterales



hebillas  
hombro



X-Backpack	QTY	N.W	G.W	C.B.M.	Size
Packing	1	1.1kg	1.25kg	0.03	650x100x400mm
10.760		Graphic Size: 500x1200mm			

## Flag Backpack Backpack

NEW



con  
mástil  
telescopico



F. Backpack	QTY	N.W	G.W	C.B.M.	Size
Packing	1	1.1kg	1.25kg	0.03	650x100x400mm
10.794		Graphic Size: 400x1250mm			

## Teardrop Banner Backpack

NEW





con  
tensor



T. Backpack	QTY	N.W	G.W	C.B.M.	Size
Packing	1	1.2kg	1.35kg	0.03	650x100x400mm
10.795		Graphic Size: 670x1150mm			

# Exterior Solutions

Wall Banner System   

## Wall Banner System

marco de aluminio  
anodizado plateado



**NEW**

Los hanger clips permiten  
cambiar fácilmente la gráfica

ideal para  
exhibiciones  
de exterior

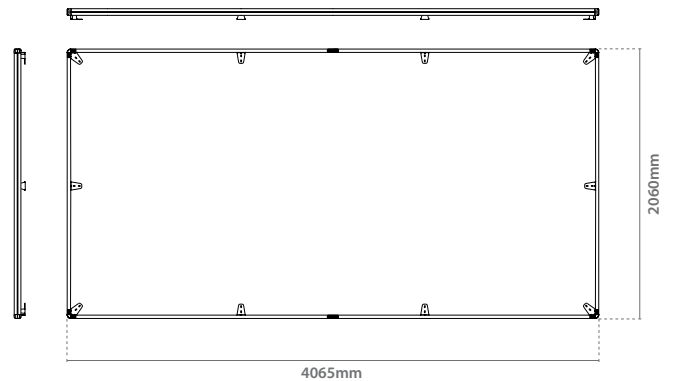
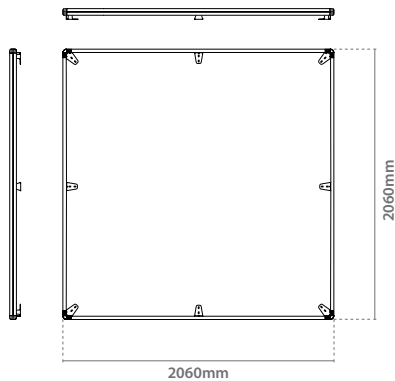
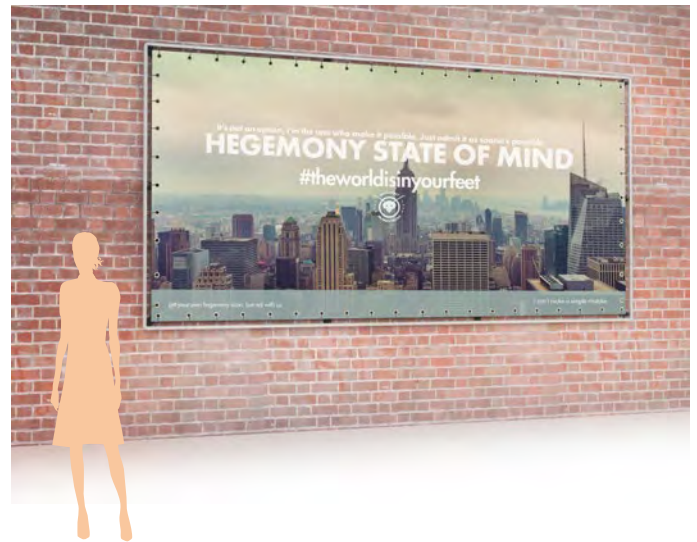
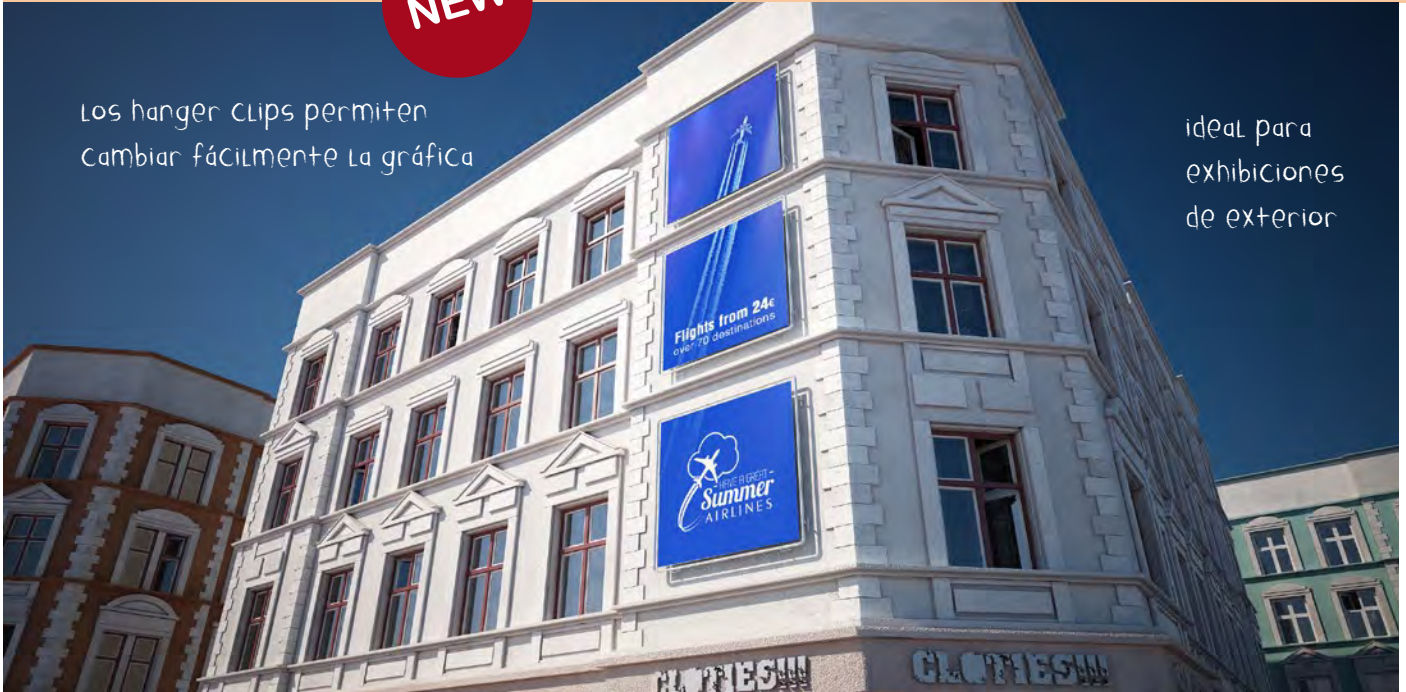



# Exterior Solutions

Wall Banner System



## Wall Banner Profile

perfil de aluminio

ligero

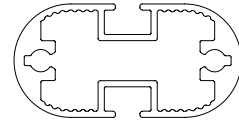
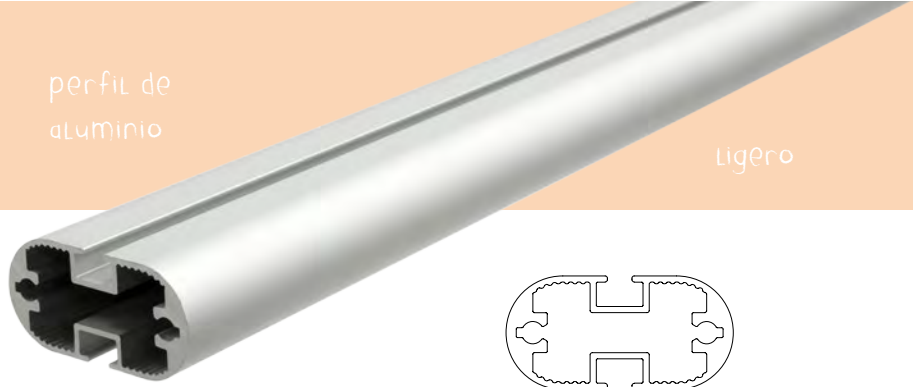
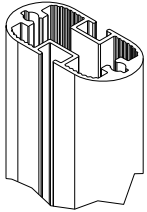

3m Bars	QTY	N.W	G.W	C.B.M.	Size
Packing	4	11.77kg	12.80kg	0.048	145x110x3010mm
<b>13.483</b>		<b>3000mm</b>		<b>x4</b>	

2m Bars	QTY	N.W	G.W	C.B.M.	Size
Packing	2	3.92kg	4.40kg	0.0115	75x75x2037mm
<b>13.484</b>		<b>2000mm</b>		<b>x2</b>	

## Wall Banner Corner Support

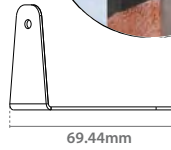
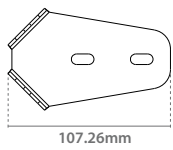

C.Support	QTY	N.W	G.W	C.B.M.	Size
Packing	4	0.52kg	0.67kg	0.0021	105x120x165mm
<b>13.485</b>				<b>x4</b>	

## Wall Banner Straight Support

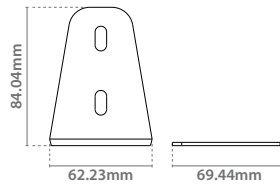

S.Support	QTY	N.W	G.W	C.B.M.	Size
Packing	4	0.41kg	0.56kg	0.0021	105x120x165mm
<b>13.486</b>				<b>x4</b>	

## Wall Banner Corner Connection

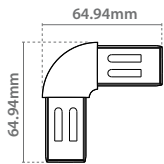

C.Connect	QTY	N.W	G.W	C.B.M.	Size
Packing	8	0.14kg	0.30kg	0.0021	105x120x165mm
<b>13.487</b>				<b>x8</b>	

## Wall Banner Profile Connection

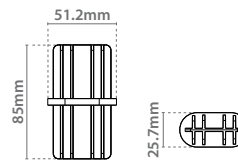

P.Connect	QTY	N.W	G.W	C.B.M.	Size
Packing	4	0.11kg	0.26kg	0.0021	105x120x165mm
<b>13.488</b>				<b>x4</b>	

## Canvas Hangers



Canvas Hangers	QTY	N.W	G.W	C.B.M.	Size
<b>13.334</b>				<b>x10</b>	

## Corner Grips



Corner Grips	QTY	N.W	G.W	C.B.M.	Size
<b>16.127</b>				<b>x20</b>	

# Exterior Solutions

Street Banner Pole | Street Banner Support



**EN** Banner flag system for wall, lamps or outdoor posts. Designed for strong wind conditions.  
**FR** Support drapeaux pour l'extérieur adaptable sur mur ou poteaux. Résiste au vent.

**PT** Sistema de bandeira para parede, postes ou outro sistema de exterior. Desenhado para suportar ventos fortes.  
**ES** Soporte de gráfica para colocación sobre pared o postes de exterior. Diseñado para resistir condiciones de viento fuerte.

## Wall-Mounted Street Banner Pole



## Hose Clamps Street Banner Pole



Screw	
10.202	Pole 800mm
10.203	Pole 1000mm
10.204	Pole 1200mm

Clamps	
10.071	Pole 800mm
10.072	Pole 1000mm
10.073	Pole 1200mm



**EN** Street Banner Support is designed for stronger wind conditions. Made of metal.  
**FR** Support visuel de petite dimension pour l'extérieur. Adaptable sur mur ou poteaux.

**PT** Mini fixador em metal para parede ou outro sistema de exterior. Desenhado para suportar ventos fortes.  
**ES** Soporte de reducido tamaño para colocación de gráfica en exterior. Permite el montaje sobre paredes o postes.

## Wall-Mounted Street Banner Support



## Hose Clamps Street Banner Support

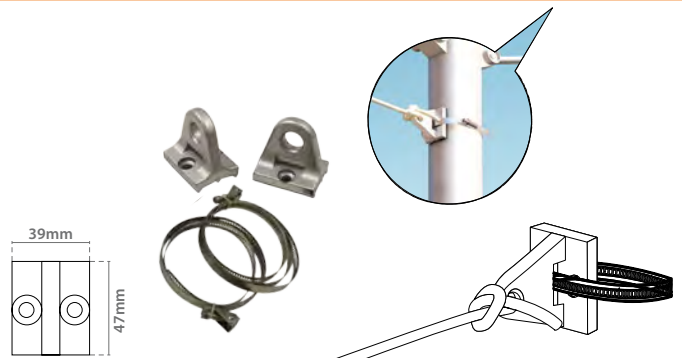
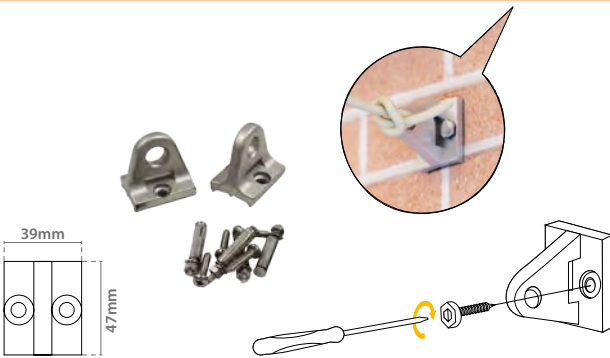

Mini Screw	
10.100	Wall-Mounted

Mini Clamps	
10.099	Hose Clamps

# Exterior Solutions

## Street Banner Lamp



EN

Banner flag system for lamp or another outdoor post. Designed for strong wind conditions. Aluminium, plastic parts. Each kit includes:

- 1 aluminium bracket.
- 1 pin and 1 ring.
- 2 stainless steel bands.
- 1 fiberglass pole 600 or 1000mm length.

FR

Potence de rue pour des poteaux à l'extérieur. Conçue pour supporter des vents forts. Chaque kit inclut:

- Une pièce d'aluminium pour la fixation au poteau.
- Une goupille avec rondelle.
- 2 attaches d'acier.
- Un poteau en fibre de verre de 600 mm ou 1000mm.

PT

Sistema de bandeirola para postes. Este suporte foi desenhado para suportar ventos fortes. Alumínio e plástico. Cada kit inclui:

- 1 Suporte.
- 2 Abraçadeiras.
- 1 Poste de fibra de vidros de 600 ou 1000 mm.
- Conectores.

ES

Soporte para la colocación de material gráfico sobre farolas, mástiles, postes, etc. Cada kit incluye:

- 1 Pieza de aluminio para suspensión a poste.
- 1 Pasador con 1 anilla.
- 2 Abrazaderas de acero.
- 1 Poste de fibra de vidrio de 600 o 1000mm.

### Lamp System



12.454



12.353

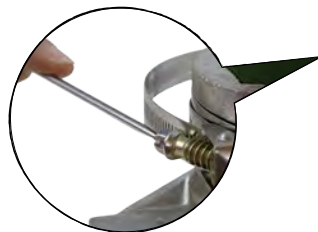

Lamp S. 600	QTY	N.W	G.W	C.B.M.	Size
Packing	1	0.6kg	1.0kg	0.0039	100x65x610mm
12.454	Pole 600mm				
Lamp S. 1000	QTY	N.W	G.W	C.B.M.	Size
Packing	1	1.0kg	1.35kg	0.006	100x65x1010mm
12.353	Pole 1000mm				

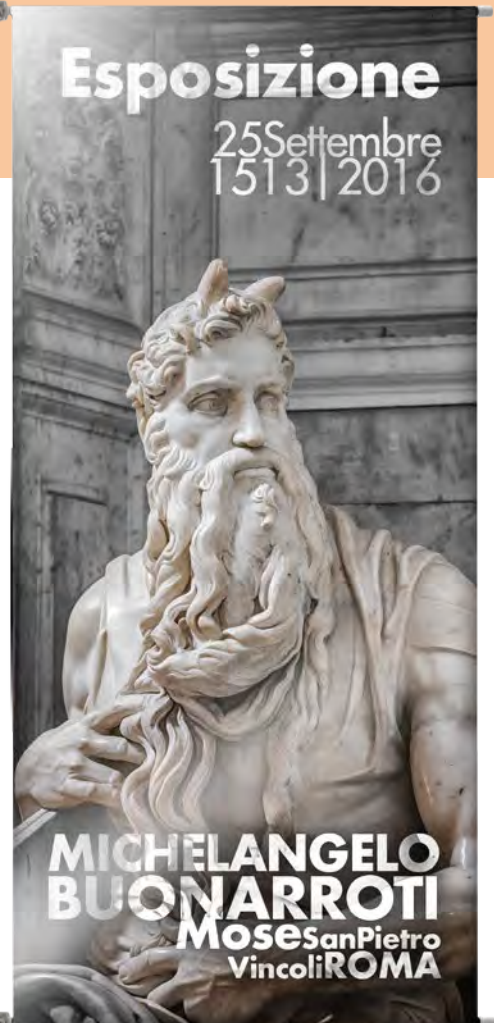

12.454

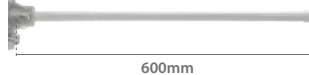

12.353



# Exterior Solutions

Flags System  

## Wall Pole

tacos y tornillos  
incluidos



- EN Wall pole is stainless steel anchoring wall system.
- FR Système d'ancrage mural en acier inoxydable.
- PT Sistema de fixação à parede em aço inoxidável.
- ES Sistema de anclaje a pared en acero inoxidable.

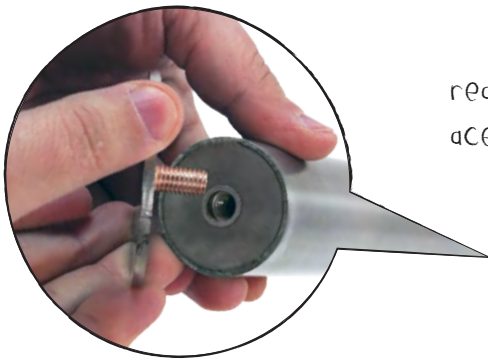

realizado en  
acero inoxidable

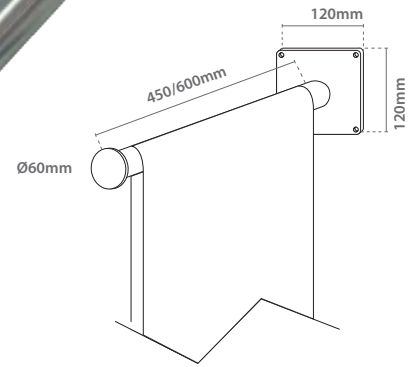

Wall Pole	QTY	N.W	G.W	C.B.M.	Size
Packing	2	2.20kg	2.64kg	0.0112	160x130x540mm
10.453		Ø40x450mm			

Wall Pole	QTY	N.W	G.W	C.B.M.	Size
Packing	2	2.46kg	3.00kg	0.0139	160x130x670mm
10.454		Ø40x600mm			

# Exterior Solutions

Flags System  

**EN** Flags made in high quality polyester. Suitable for indoor and outdoor use. Material: Polyester 117g.

**FR** Drapeaux en polyester de haute qualité pour une utilisation à l'intérieur ou à l'extérieur. Polyester de 117g.

**PT** Bandeiras fabricadas em poliéster de alta qualidade. Adequado para interior ou exterior. Poliéster 117g.

**ES** Banderas de poliéster de alta calidad. Adequado para interior y exterior. Material: Poliéster 117g.

## Standar Flags System

Standar Flags System		Basic Sew	1	2	4	5	7	3	6
10.379	700x1000mm								
10.882	1500x1000mm								
10.883	2000x1200mm								
10.884	2500x1500mm								

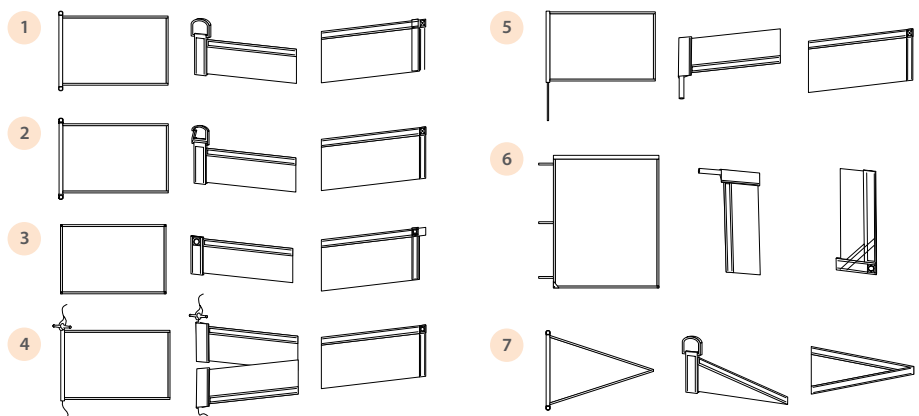
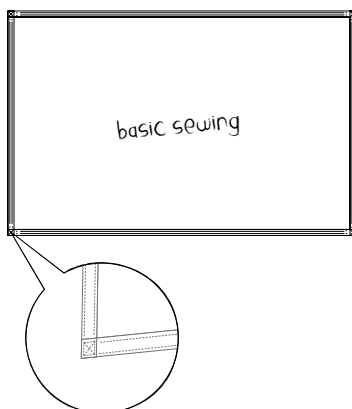

# Exterior Solutions

Flags System  



# Exterior Solutions

## Flags System



### Internationals



### Universities



### Sports

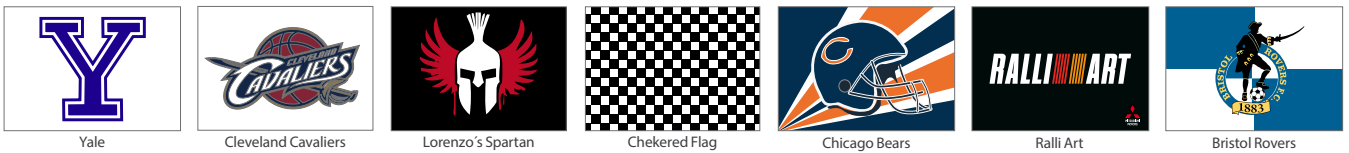

Check our website [www.cashdisplay.com](http://www.cashdisplay.com) for more models or customized printing flags / Consultez notre site [www.cashdisplay.com](http://www.cashdisplay.com) pour plus de modèles de drapeaux / Encontre mais modelos ou impressões personalizadas no nosso site em [www.cashdisplay.com](http://www.cashdisplay.com) / Visita nuestra web [www.cashdisplay.com](http://www.cashdisplay.com) para más modelos e impresiones personalizadas.

# Barrier Banner

Barrier Banner    

Rio  
Barrier Banner

**NEW**

estructura de aluminio

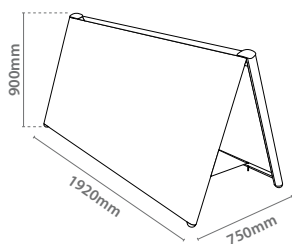

Rio	QTY	N.W	G.W	C.B.M.	Size
Packing	1	8.8kg	9kg	0.04	210x1900x1000mm
10.790		Graphic Size: 2080x900mm			

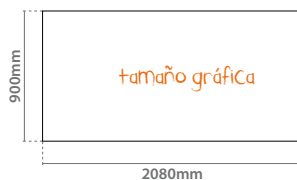

Parana  
Barrier Banner



- EN** Consists of aluminium frame, loops, hooks for fixing the digitally printed banner and tent pegs for fixing the frame on soft ground. Price includes bag. Size: 2470x955mm.
- FR** Cadre en aluminium pour l'exposition de visuel. Nœuds et crochets inclus pour la fixation des impressions et cheville pour la fixation sur sol mou. Dimensions: 2470x955mm.
- PT** Estrutura consistente fabricada em alumínio. Inclui laços e ganchos para colocar a impressão e cravelhas para fixar a estrutura a solos arenosos. Dimensões: 2470x955mm.
- ES** Marco de aluminio para exposición de gráfica. Incluye lazos, ganchos para la fijación de las impresiones y clavijas para fijar el marco en el suelo blando. Tamaño: 2470x955mm.

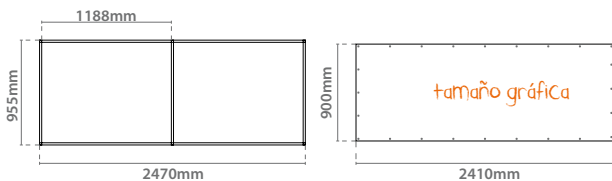

Parana	QTY	N.W	G.W	C.B.M.	Size
Packing	1	7kg	8.1kg	0.049	200x200x1220mm
10.548		Graphic Size: 2410x900mm			





# Barrier Banner | Exhibition Wall

Barrier Banner | Exhibition Wall



Manaus  
Barrier Banner



acabado en  
aluminio negro

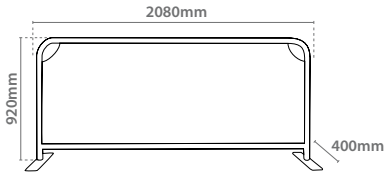
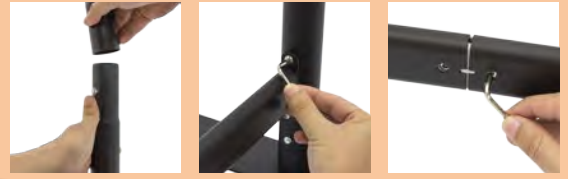

se suministra  
con pinchos

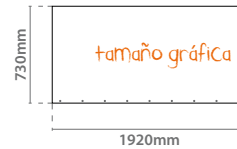
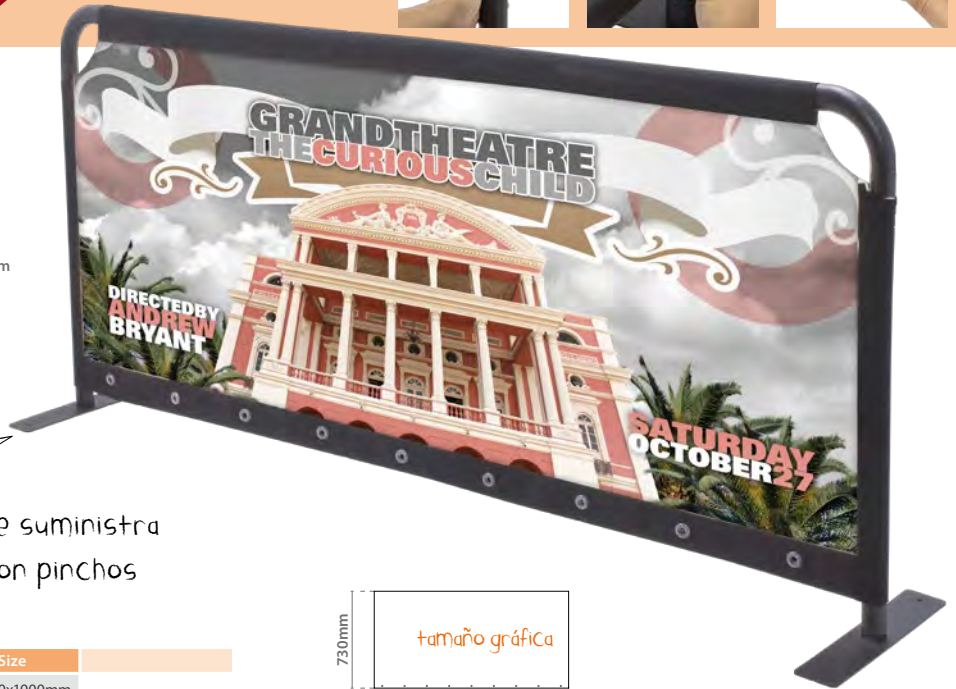

Manaus	QTY	N.W	G.W	C.B.M.	Size
Packing	1	5kg	5.2kg	0.04	210x190x1000mm
10.791	Graphic Size: 1920x730mm				

## Arenas Exhibition Wall

- EN Folding panel kit. Quick and easy to assemble. Composed by 8 pieces of 600x900mm (each panel). Aluminium, plastic parts. Graphic size: 538x845mm for each panel.
- FR Mur modulaire pour présentation. Composé de 8 pièces de 600x900mm. Idéal pour la présentation de produits, conférences de presse, etc. Format visuel: 538x845mm / panneau.
- PT Biombo modular de fácil montagem composto por 8 painéis de 600x900mm. Medidas da impressão: 538x845mm cada painel.
- ES Muro modular para presentaciones. Compuesto por 8 piezas de 600x900mm. Ideal para ruedas de prensa, presentaciones de producto, promociones etc. Área gráfica: 538x845mm cada panel.

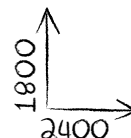
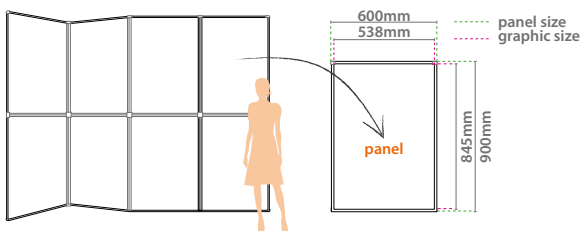

paneles plegables

Arenas	QTY	N.W	G.W	C.B.M.	Size
Packing	1	7.3kg	11kg	0.12	640x200x950mm
10.041	Graphic Size: 2400x1800mm				

# Fashion Pop Up

Fashion Pop Up

## Cumbre Pop Up Fashion



doble  
Cara

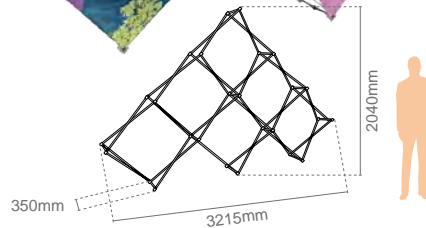

- EN PopUpFashion“triangle”withstretch-printsivesa3-Deffect. New printing technology special for fabric. Aluminium.
- FR Pop up triangulaire pour impression en tissu qui donne un effet 3D. Fabriqué en aluminium.
- PT Pop up triangular para tecido que dá um efeito 3D. Fabricado em alumínio com fecho magnético. Ideal têxtil.
- ES Pop Up de estructura triangular de aluminio y cierre magnético. Permite la colocación de distintas gráficas y configuraciones. Ideal para material textil.

Cumbre	QTY	N.W	G.W	C.B.M.	Size
Packing	1	6.2kg	7.7kg	0.05	240x240x840mm
10.423	Structure Size: 3215x2040x350mm				

## Alia Pop Up Fashion ideal for fabric printing



doble  
Cara



- EN Pop Up Fashion “column” with stretch-prints gives a 3-D effect. New printing technology for fabric. Aluminium.
- FR Pop up triangulaire pour impression en tissu qui donne un effet 3D. Fabriqué en aluminium.
- PT Coluna promocional Pop Up. Fabricado em alumínio com fecho magnético. Ideal para material têxtil.
- ES Columna promocional Pop Up. Fabricado en aluminio y con cierre magnético. Ideal para material textil.

Alia	QTY	N.W	G.W	C.B.M.	Size
Packing	1	5kg	6.5kg	0.03	190x190x830mm
10.424	Structure Size: 2215x770x350mm				

## Villoria Totem Pop Up



- EN PopUp exhibition stand Tower. Aluminium. Display size: 600x2300mm. Graphic size: 595x2300mm x3 panels.
- FR Totem promotionnel magnétique. Dimension du support: 600x2300mm. Visuels : 595x2300mm x3 panneaux.
- PT Pop Up circular em alumínio. Medidas de suporte: 600x2300mm. Medidas da impressão: 595x2300mm x3 painéis.
- ES Tótem promocional para gráfica. Medidas del soporte: 600x2300mm. Tamaño de gráfica: 595x2300mm x3 paneles.

Villoria	QTY	N.W	G.W	C.B.M.	Size
Packing	1	9kg	12kg	0.08	350x250x850mm
10.040	Graphic Size: 595x2300mm				

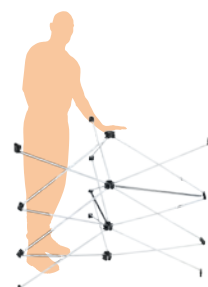

pop up  
magnético

2300  
637

# Velcro Pop Up

Ipanema Pop Up     

EN	<p>Economic graphic promo for Wall. The graphic can be replaced quickly thanks to its velcro. Made of aluminum with silver finishing.</p> <p>Contains:</p> <ul style="list-style-type: none"> <li>• Soft-Case. Made of black fabric.</li> <li>• Roll of Velcro.</li> </ul>	PT	<p>Pop-Up econômico com sistema de velcro que permite a mudança de imagem de forma fácil e rápida. Alumínio com acabamento prateado.</p> <p>Conteúdo:</p> <ul style="list-style-type: none"> <li>• Mala de transporte em nylon preto.</li> <li>• Rolo de velcro.</li> </ul>
FR	<p>Mur promotionnel économique. Le visuel peut être changé rapidement grâce à son système velcro. Fabriqué en aluminium avec finition couleur argent.</p> <ul style="list-style-type: none"> <li>• Valise de transport en nylon noir.</li> <li>• Rouleau de velcro.</li> </ul>	ES	<p>Muro promocional económico para gráfica. La gráfica puede ser sustituida de forma rápida gracias a su sistema de velcro. Fabricado en aluminio con acabado en color plata. Contiene:</p> <ul style="list-style-type: none"> <li>• Maleta fabricada en tela.</li> <li>• Rollo de velcro.</li> </ul>

Ipanema 3x3 | 4x3  
Velcro Pop Up

**NEW**

**ECONOMIC**



*quick and easy*

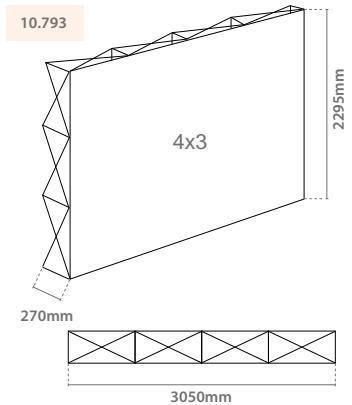
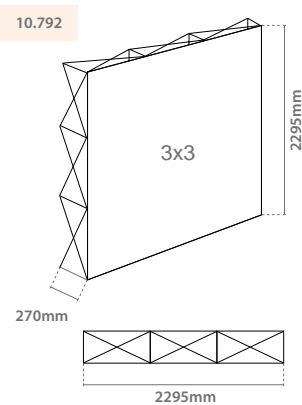

Ipanema 3x3	QTY	N.W	G.W	C.B.M.	Size
Packing	1	7.65kg	8.35kg	0.06	855x235x280mm
10.792	3x3	Graphic Size: 2295x2295mm			

Ipanema 4x3	QTY	N.W	G.W	C.B.M.	Size
Packing	1	8.65kg	9.35kg	0.06	855x235x280mm
10.793	4x3	Graphic Size: 3050x2295mm			

# Velcro Pop Up

Pop Up Cangas



EN

Straight graphic promo for Wall. The graphic can be replaced quickly thanks to its velcro. Made of aluminum in silver finishing color. Contains:  
 • Trolley carry bag.  
 • Roll of Velcro.  
 • 2 Spotlights.

FR

Mur promotionnel droit. Le visuel peut être changé rapidement grâce à son système velcro. Fabriqué en aluminium avec finition couleur argent. Inclus:  
 • Valise type Trolley en nylon.  
 • Rouleau de velcro.  
 • 2 Foyers d'éclairage.

PT

Pop-Up com sistema de velcro que permite a mudança de imagem de forma fácil e rápida. Fabricado em alumínio com acabamento prateado. Conteúdo:  
 • Mala em tecido tipo carinho.  
 • Rolo de velcro.  
 • 2 Focos de Iluminação.

ES

Muro promocional recto para gráfica. La gráfica puede ser sustituida de forma rápida gracias a su sistema de velcro. Fabricado en aluminio con acabado en color plata. Contiene:  
 • Maleta tela tipo Trolley.  
 • Rollo de velcro.  
 • 2 Focos de Iluminación.

Cangas 3x3 | 4x3  
Velcro Pop Up



muro recto



quick and easy

10.413

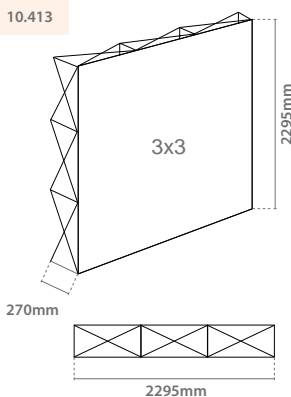

10.414

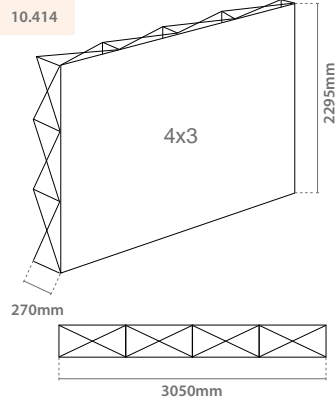

Cangas 3x3	QTY	N.W	G.W	C.B.M.	Size
Packing	1	13.20kg	15kg	0.2	450x450x950mm
10.413	3x3	Graphic Size: 2295x2295mm			

Cangas 4x3	QTY	N.W	G.W	C.B.M.	Size
Packing	1	16.35kg	17.95kg	0.2	450x450x950mm
10.414	4x3	Graphic Size: 3050x2295mm			

# Velcro Pop Up

Pop Up Cangas



Cangas 5x3 | 6x3 | 7x3  
Velcro Pop Up



10.938

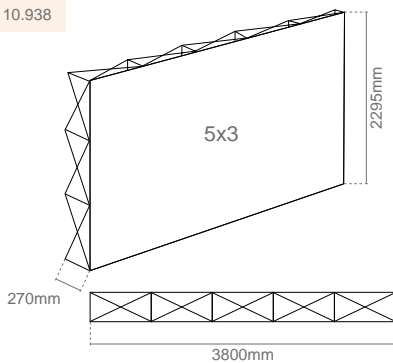

Cangas 5x3	QTY	N.W	G.W	C.B.M.	Size
Packing	1	16.95kg	18.30kg	0.201	460x460x950mm
10.938	Graphic Size: 3800x2295mm				

+ trolley carry bag  
+ roll of velcro  
+ 2 spotlights

10.939

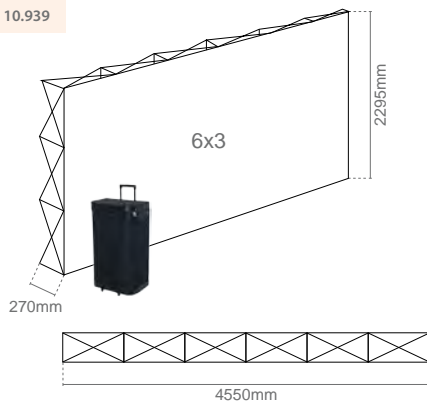

Cangas 6x3	QTY	N.W	G.W	C.B.M.	Size
Packing	1	20.50kg	21.90kg	0.200	540x400x950mm
10.939	Graphic Size: 4550x2295mm				

10.951

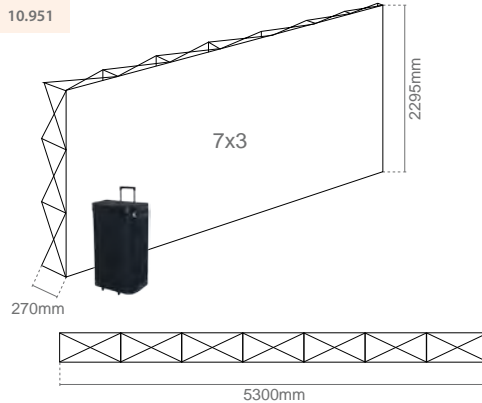

Cangas 7x3	QTY	N.W	G.W	C.B.M.	Size
Packing	1	22.65kg	24.50kg	0.201	540x400x950mm
10.951	Graphic Size: 5300x2295mm				

# Pop Up

## Pop Up Laredo



EN

Aluminium flexible Pop Up adapted for curved or straight wall system. Quick and easy assembly. The kit includes:

- Trolley carry bag.
- Magnetic strip roll.

FR

Mur promotionnel droit ou courbé en aluminium. Inclus:

- Valise type Trolley en nylon.
- Bandes de suspension.

PT

Painel promocional recto ou curvo. Estrutura em alumínio. Conteúdo:

- Mala de tecido tipo Trolley.
- Rolo de Íman.

ES

Muros promocionales rectos o curvos. Estructura en aluminio. Contenido:

- Maleta tela tipo Trolley.
- Rollo de Ímán.

### Laredo 3x3 Straight

fácil de  
transportar

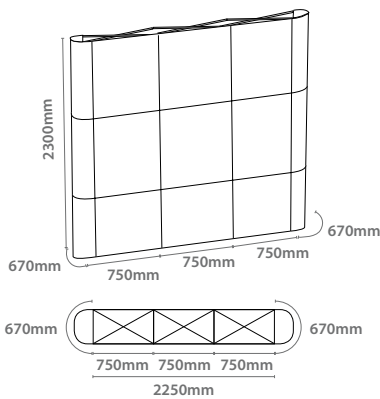

Laredo S	QTY	N.W	G.W	C.B.M.	Size
Packing	1	17.15kg	18.6kg	0.12	390x340x920mm
10.520	Graphic Size:		670x2300mm x2 750x2300mm x3		



### Laredo 3x3 Curved

fácil  
almacenaje

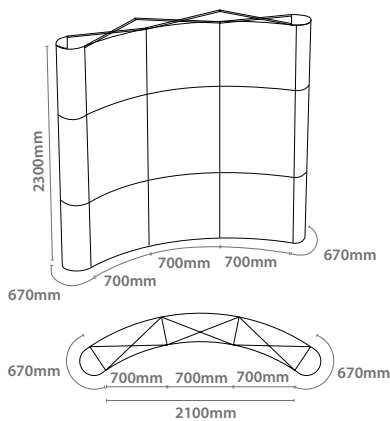

Laredo C	QTY	N.W	G.W	C.B.M.	Size
Packing	1	17.15kg	18.6kg	0.12	390x340x920mm
10.547	Graphic Size:		670x2300mm x2 700x2300mm x3		



# Pop Up

Pop Up Llanes



Llanes 4x3  
Straight

fácil  
montaje

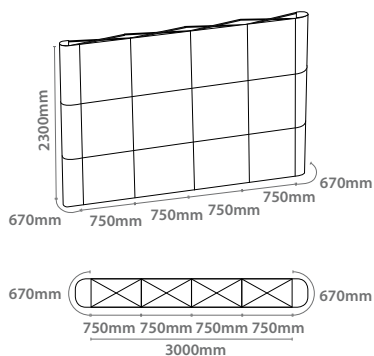

Llanes S	QTY	N.W	G.W	C.B.M.	Size
Packing	1	21.7kg	22.1kg	0.12	390x340x920mm
10.513	Graphic Size: 670x2300mm x2 750x2300mm x4				

maleta trolley incluida

Llanes 4x3  
Curved

estructura  
de aluminio

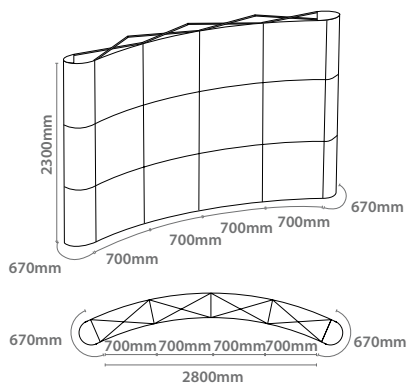

Llanes C	QTY	N.W	G.W	C.B.M.	Size
Packing	1	21.7kg	22.1kg	0.12	390x340x920mm
10.519	Graphic Size: 670x2300mm x2 700x2300mm x4				

maleta trolley incluida

# Pop Up

Pop Up Arevalo



## Arevalo 2x3 Vertical

fácil  
transporte

- EN Hard case with wheels included.
- FR Inclus valise rigide avec roue.
- PT Inclui mala rígida com rodas.
- ES Incluye maleta rígida con ruedas.

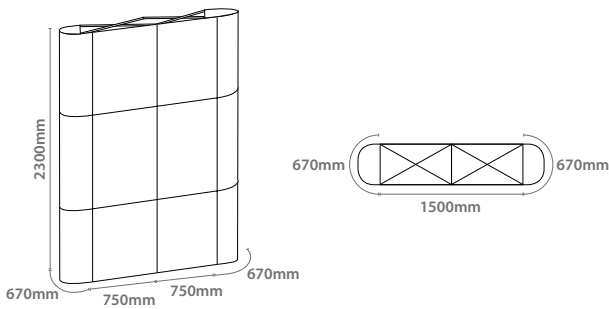

Arevalo V	QTY	N.W	G.W	C.B.M.	Size
Packing	1	29.4kg	32.6kg	0.32	730x430x1010mm
10.369	Graphic Size: 670x2300mm x2 750x2300mm x2				



incluye maleta rígida con ruedas

## Arevalo 3x2 Horizontal

fácil  
montaje

- EN Hard case with wheels included.
- FR Inclus valise rigide avec roue.
- PT Inclui mala rígida com rodas.
- ES Incluye maleta rígida con ruedas.

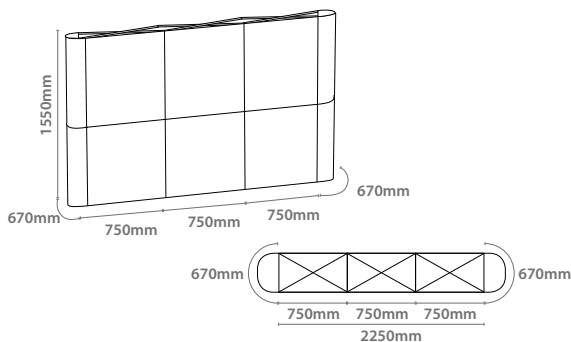

Arevalo H	QTY	N.W	G.W	C.B.M.	Size
Packing	1	28.8kg	32kg	0.13	720x430x1010mm
10.425	Graphic Size: 670x1550mm x2 750x1550mm x3				



incluye maleta rígida con ruedas



# Pop Up

Pop Up Gredos



## Gredos 3x3 Curved

fácil almacenamiento

- EN Hard case with wheels included.
- FR Inclus valise rigide avec roue.
- PT Inclui mala rígida com rodas.
- ES Incluye maleta rígida con ruedas.



incluye maleta rígida con ruedas

10.367

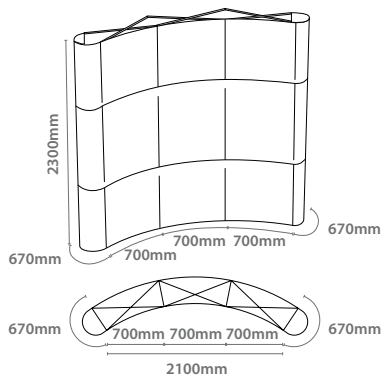

10.398

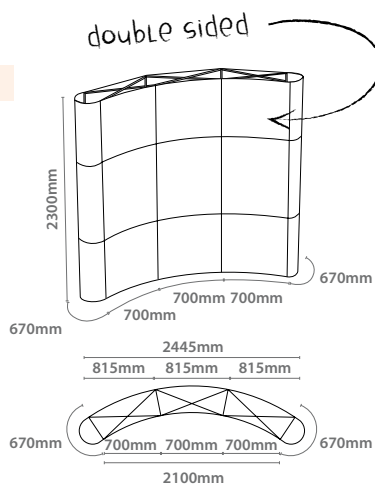

Gredos C1	QTY	N.W	G.W	C.B.M.	Size
Packing	1	32.25kg	35.45kg	0.32	730x430x1010mm
10.367	Graphic Size:		670x2300mm x2	700x2300mm x3	

Gredos C2	QTY	N.W	G.W	C.B.M.	Size
Packing	1	34.75kg	37.95kg	0.32	730x430x1010mm
10.398	Graphic Size:		670x2300mm x2	700x2300mm x3	
			815x2300mm	x3	

# Pop Up

Pop Up Gredos



Gredos 3x3  
Straight

estructura  
de aluminio

- EN Hard case with wheels included.
- FR Inclus valise rigide avec roue.
- PT Inclui mala rígida com rodas.
- ES Incluye maleta rígida con ruedas.

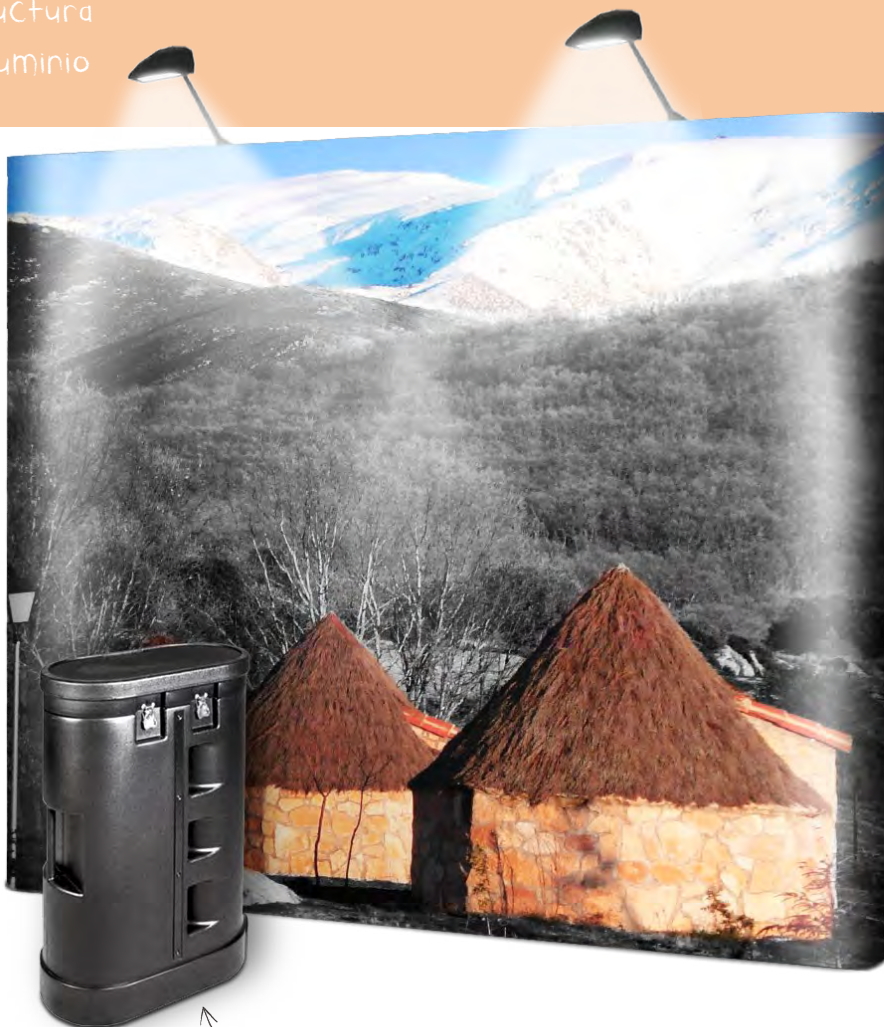

incluye maleta rígida con ruedas

10.366

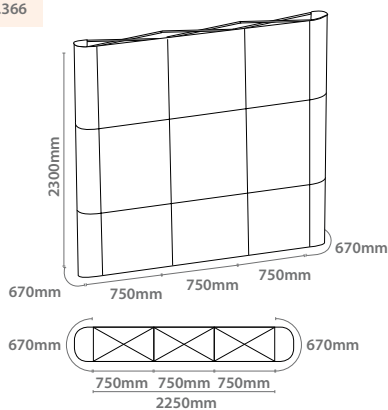

10.397

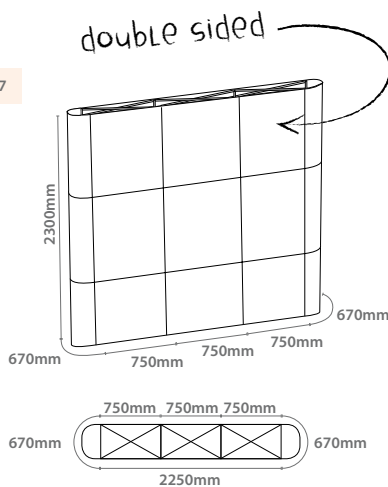

Gredos S1	QTY	N.W	G.W	C.B.M.	Size
Packing	1	32.25kg	35.45kg	0.32	730x430x1010mm
10.366	Graphic Size:		670x2300mm x2 750x2300mm x3		

Gredos S2	QTY	N.W	G.W	C.B.M.	Size
Packing	1	34.75kg	37.95kg	0.32	730x430x1010mm
10.397	Graphic Size:		670x2300mm x2 750x2300mm x6		

# Pop Up

Pop Up Madrigal



Madrigal 4x3  
Curved

fácil almacenamiento



incluye maleta rígida con ruedas

double sided

10.037

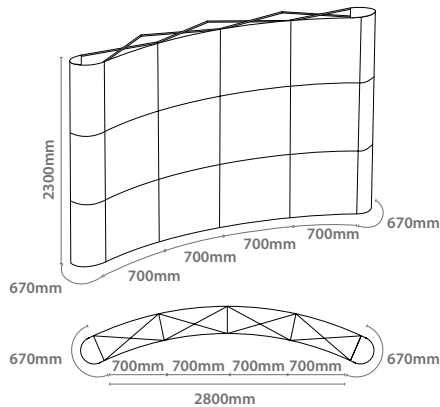

10.400

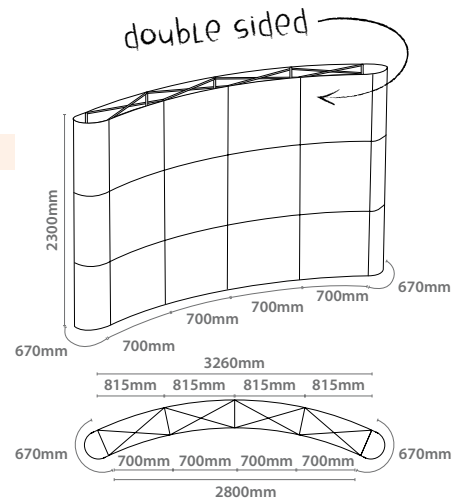

Madrigal C1	QTY	N.W	G.W	C.B.M.	Size
Packing	1	36.3kg	39.5kg	0.3	710x430x1000mm
10.037	Graphic Size:		670x2300mm x2 700x2300mm x4		

Madrigal C2	QTY	N.W	G.W	C.B.M.	Size
Packing	1	44.5kg	47.7kg	0.3	710x430x1000mm
10.400	Graphic Size:		670x2300mm x2 700x2300mm x4 815x2300mm x4		

# Pop Up

Pop Up Madrigal



Madrigal 4x3  
Straight

fácil almacenamiento



incluye maleta rígida con ruedas

10.036

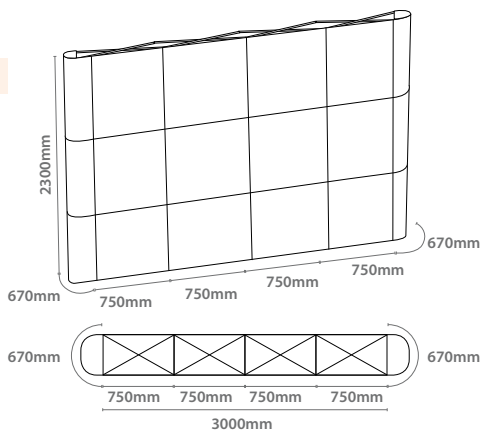

10.857

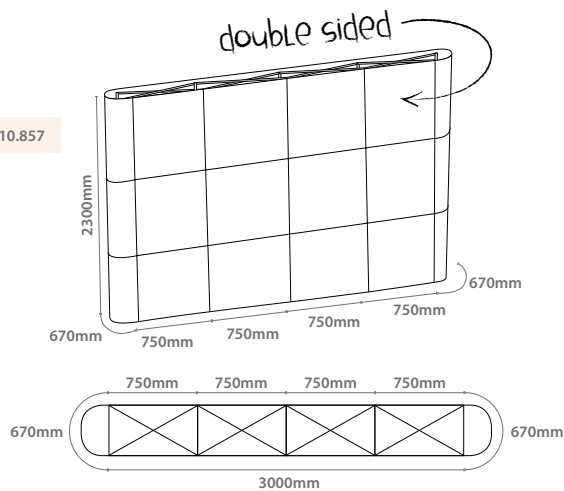

Madrigal S1	QTY	N.W	G.W	C.B.M.	Size
Packing	1	36.3kg	39.5kg	0.3	730x430x1000mm
10.036	Graphic Size: 670x2300mm x2 700x2300mm x4				

Madrigal S2	QTY	N.W	G.W	C.B.M.	Size
Packing	1	44.5kg	47.7kg	0.30	730x430x1000mm
10.857	Graphic Size: 670x2300mm x2 750x2300mm x8				

# Pop Up

Pop Up Nazare



Nazare 5x3

fácil y rápido montaje

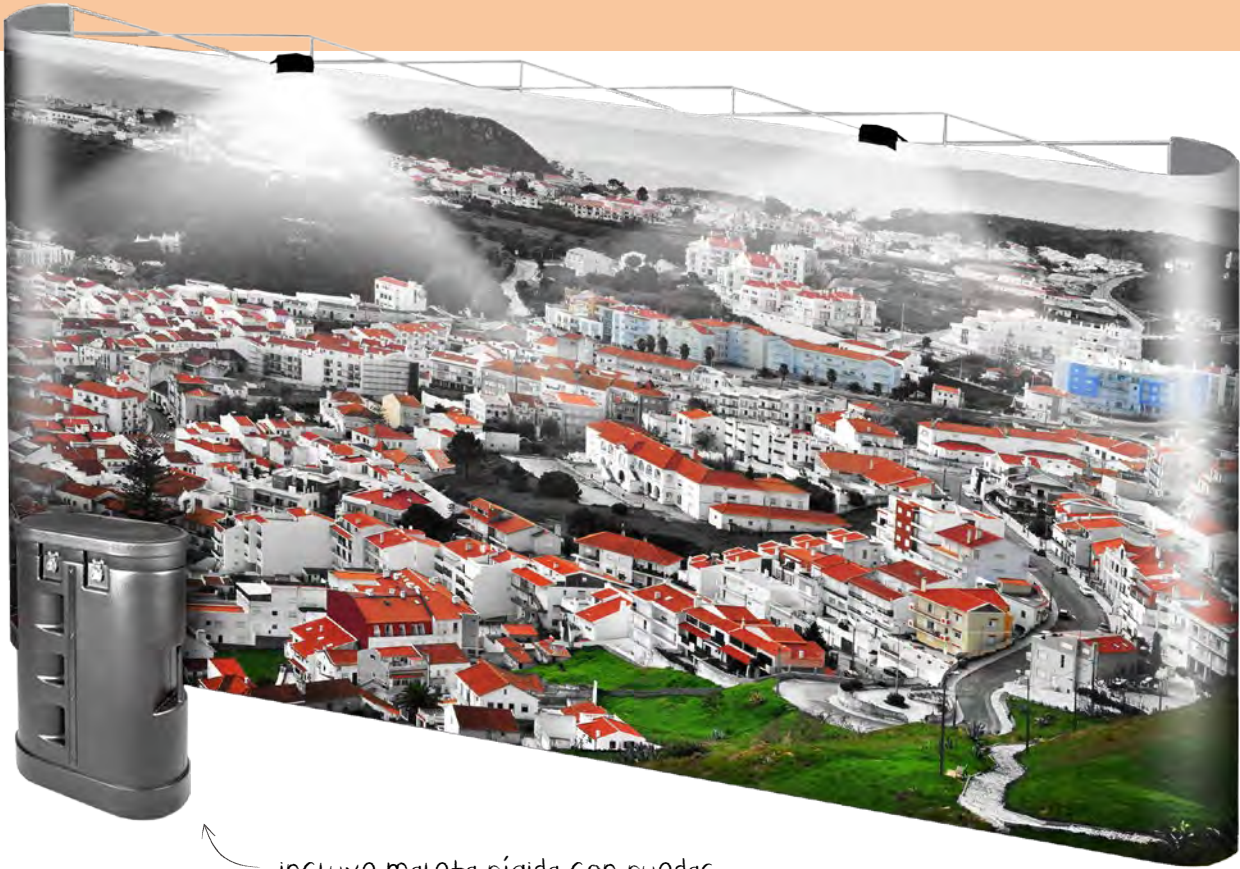

incluye maleta rígida con ruedas

muro recto

10.236

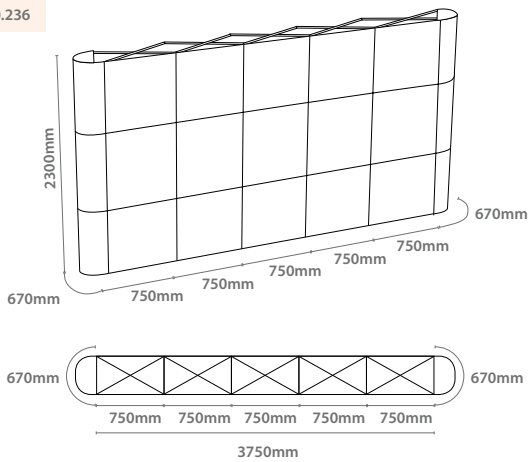

curved wall

10.237

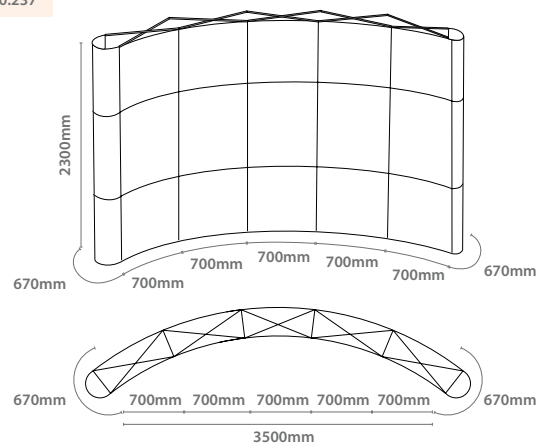

Nazare S	QTY	N.W	G.W	C.B.M.	Size	
Packing	1	40.1kg	43.3kg	0.32	730x430x1010mm	
10.236	Graphic Size:		670x2300mm x2 750x2300mm x5			

Nazare C	QTY	N.W	G.W	C.B.M.	Size	
Packing	1	40.1kg	43.3kg	0.32	730x430x1010mm	
10.237	Graphic Size:		670x2300mm x2 700x2300mm x5			

# Pop Up

Pop Up Teide 8x3 "S"



Teide 8x3 "S"

pop up gran tamaño



- EN Includes two hard cases with wheels.
- FR Valise à roulettes incluse.
- PT Inclui mala de transporte com rodas.
- ES Incluye dos maletas rígidas con ruedas.



4 focos incluidos



10.234

double sided

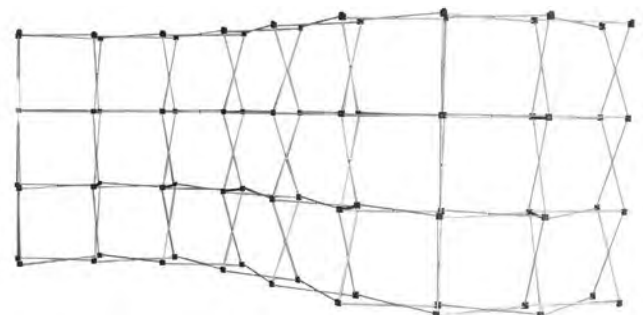
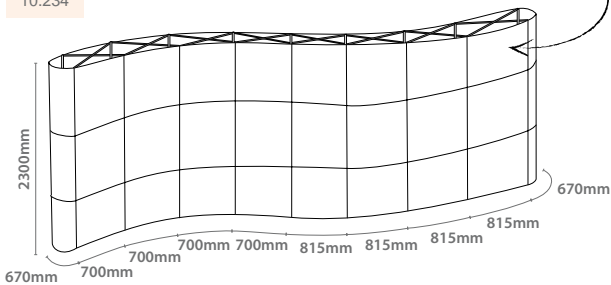

Teide S	QTY	N.W	G.W	C.B.M.	Size
Packing	2	35.6kg 30kg	36.6kg 31kg	0.31 0.31	730x430x1010mm 730x430x1010mm
10.234		Graphic Size: 670x2300mm x2 700x2300mm x8 815x2300mm x8			

# Display Accessories

## Trolley Cases

### Maqueda Trolley Hard-Case



- EN** PVC Hard-Case with rubber wheels and handle. Metal clasps. It can be used as an occasional table or complementing a stand point of sale. It can be labeled with graphic. Graphic area: 1810x795mm.
- FR** Valise de transport type Hard Case, fabriquée en PVC noir, avec roue en caoutchouc et avec poignée. Fermoirs métalliques. Peut-être utilisée comme table auxiliaire complétant un stand ou un point de vente. Un visuel peut être mis autour de la valise. Format du visuel : 1810x795mm.
- PT** Mala de transporte com rodas de borracha, pega e fechaduras metálicas. Pode ser usada como mesa ou rotulada. Área de impressão: 1810x795 mm.
- ES** Carrito de transporte rígido, fabricado en PVC negro, con ruedas de goma y asa. Cierres metálicos. Puede usarse como mesa auxiliar complementando un stand. Puede rotularse con gráfica. Área gráfica: 1810x795mm.



Maqueda	QTY	N.W	G.W	C.B.M.	Size
Packing	1	13kg	15.2kg	0.3	710x420x1000mm
10.058			700x400x960mm		

### Table Top for Pop Up



Table Top	QTY	N.W	G.W	C.B.M.	Size
Uni.	1	4.2kg	5.0kg	0.05	830x270x220mm
10.309					785x480x16mm
10.310					785x480x16mm

### Noves Trolley Hard-Case

- EN** Hard-Case made of black PVC with rubber wheels and handle. Metal clasps. It can be used as an occasional table or complementing a stand point of sale. It can be labeled with graphic. Graphic area: 1450x745mm.
- FR** Valise de transport type Hard Case, fabriqué en PVC noir, avec roue en caoutchouc et anse. Fermoirs métalliques. Peut être utilisé comme table auxiliaire complétant un stand ou un point de vente. Taille graphique: 1450 x 745mm.
- PT** Mala de transporte com rodas de borracha, pega e fechaduras metálicas. Pode ser usada como mesa ou rotulada. Área de impressão: 1450x795 mm.
- ES** Carrito de transporte rígido, fabricado en PVC negro, con ruedas de goma y asa. Cierres metálicos. Puede usarse como mesa auxiliar complementando un stand o punto de venta. Área gráfica: 1450 x 745mm.



Noves	QTY	N.W	G.W	C.B.M.	Size
Uni.	1	7kg	9.1kg	0.18	410x430x1000mm
10.059			400x380x960mm		

### Escalona Trolley Soft-Case

- EN** Trolley made of black nylon, with wheels and two handles type straps and an extendable handle. Closures with zippers.
- FR** Valise de transport en toile de nylon noire, avec roues, deux anses et poigné extensible. Fermée par une fermeture à glissière.
- PT** Trolley em nylon preto com rodas duas asas e pega extensível. Fecha-se com zíper.
- ES** Carrito tipo Trolley fabricado en nylon negro, con ruedas, dos correas y un asa extensible. Cierres mediante cremalleras.

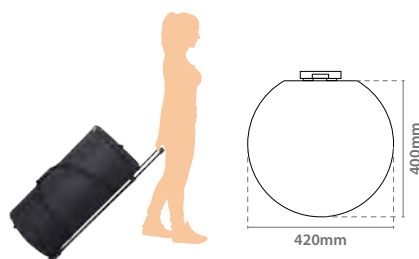

Escalona	QTY	N.W	G.W	C.B.M.	Size
Packing	1	15kg	18.6kg	0.12	680x170x1030mm
10.060			Height: 790mm		

# Display Accessories

## Trolley Cases | Spotlights Bags

EN Soft-Case Trolley. Made of black fabric.  
FR Valise de transport en nylon noir.

PT Mala de transporte em nylon preto.  
ES Carrito de transporte tipo Trolley, fabricado en tela.

### Trolley Soft-Case



Soft Trolley	QTY	N.W	G.W	C.B.M.	Size
Packing	1	3.75kg	5.70kg	0.13	445x265x1160mm

13.456

\* Counter is not included / Présentoir non inclus / Balcão não incluídos / Mostrador no incluído.

### Trolley Soft-Case



Soft Trolley	QTY	N.W	G.W	C.B.M.	Size
Packing	1	4.15kg	5.50kg	0.12	440x340x820mm

13.457

\* Counter is not included / Présentoir non inclus / Balcão não incluídos / Mostrador no incluído.

### Oxford Bag Roll Up Spotlights



EN Oxford nylon bag for Roll Up Spotlights.  
FR Housse en nylon pour spotlights de Roll Up.  
PT Mala Oxford em nylon para focos de Roll Up.  
ES Bolsa Oxford de nylon para focos de Roll Up.



Oxford Bag	QTY	N.W	G.W	C.B.M.	Size
Packing	1	0.10kg	0.20kg	0.002	190x30x370mm

13.454

\* Spotlights not included / Spotlights non inclus / Focos não incluídos / Focos no incluídos.

### Oxford Bag Pop Up Spotlights



EN Oxford nylon bag for Pop Up Spotlights.  
FR Housse en nylon pour spotlights de Pop Up.  
PT Mala Oxford em nylon para focos de Pop Up.  
ES Bolsa Oxford de nylon para focos de Pop Up.



Oxford Bag	QTY	N.W	G.W	C.B.M.	Size
Packing	1	0.15kg	0.20kg	0.002	160x30x540mm

13.455

\* Spotlights not included / Spotlights non inclus / Focos não incluídos / Focos no incluídos.



# Display Accessories

## Roll Up Bags

### Single Oxford Bag



### Double Padded Bag



EN Single Oxford black Bag with zip for Roll Up.

FR Housse pour Roll Up avec fermeture à glissière.

PT Saco de transporte com fecho para Roll Up.

ES Bolsa para Roll Up Simple con cremallera.

EN Double padded black bag with zip for Roll Up.

FR Housse matelassée pour Roll Up avec fermeture à glissière.

PT Saco de transporte almofadado com fecho para Roll Up.

ES Bolsa negra acolchada con cremallera para Roll Up.



Single Bag	QTY	N.W	G.W	C.B.M.	Size
Packing	1	0.12kg	0.22kg	0.003	120x30x980mm
13.461	For Roll Up 850mm				

Single Bag	QTY	N.W	G.W	C.B.M.	Size
Packing	1	0.15kg	0.25kg	0.003	120x30x1030mm
13.462	For Roll Up 1000mm				

\* Roll Up not included / Roll Up non inclus / Roll Up não incluídos / Roll Up no incluídos.

Double Bag	QTY	N.W	G.W	C.B.M.	Size
Packing	1	0.40kg	0.60kg	0.004	120x40x980mm
13.463	For Roll Up 850mm				

Double Bag	QTY	N.W	G.W	C.B.M.	Size
Packing	1	0.50kg	0.70kg	0.004	120x40x1030mm
13.464	For Roll Up 1000mm				

\* Roll Up not included / Roll Up non inclus / Roll Up não incluídos / Roll Up no incluídos.

### Double Padded Zipped Bag



### Eva Bag Deluxe



EN Double Padded black bag with side zip for Roll Up.

FR Housse matelassée pour Roll Up avec fermeture latérale.

PT Saco de transporte almofadado com fecho lateral para Roll Up.

ES Bolsa acolchada negra para Roll Up con cremallera lateral.

EN Deluxe black bag with side zip for Roll Up.

FR Housse «Deluxe» pour Roll Up avec fermeture à glissière latérale.

PT Saco de transporte de alta qualidade com fecho lateral para Roll Up.

ES Bolsa "Deluxe" para Roll Up con cremallera lateral.



Double Bag	QTY	N.W	G.W	C.B.M.	Size
Packing	1	0.40kg	0.60kg	0.004	120x40x980mm
13.459	For Roll Up 850mm				

Double Bag	QTY	N.W	G.W	C.B.M.	Size
Packing	1	0.50kg	0.70kg	0.004	120x40x1030mm
13.460	For Roll Up 1000mm				

\* Roll Up not included / Roll Up non inclus / Roll Up não incluídos / Roll Up no incluídos.

Eva Case	QTY	N.W	G.W	C.B.M.	Size
Packing	1	1.05kg	1.45kg	0.016	130x130x950mm
13.472	For Roll Up 850mm				

\* Roll Up not included / Roll Up non inclus / Roll Up não incluídos / Roll Up no incluídos.

# Display Accessories

Pop Up Bars | Pop Up Connecting Pieces



## Top and Bottom Bar Graphic (3x3)

## Top and Bottom Bar Graphic (4x3)

EN	Top and bottom bars for Pop Up 3x3.
FR	Kit de bandes pour Pop Up 3x3.
PT	Kit de tiras de suspensão para Pop Up 3x3.
ES	Set de Perchas/Zócalos para Pop Up 3x3.

EN	Top and bottom bars for Pop Up 4x3.
FR	Kit de bandes pour Pop Up 4x3.
PT	Kit de tiras de suspensão para Pop Up 4x3.
ES	Set de Perchas/Zócalos para Pop Up 4x3.



Straight Bar	QTY	N.W	G.W	C.B.M.	Size
Set	10	0.68kg	0.7kg	0.0008	55x20x750mm
10.714	Straight 3x3				
C.Front Bar	QTY	N.W	G.W	C.B.M.	Size
Set	10	0.7kg	0.72kg	0.0007	55x20x700mm
10.715	Curved / Front 3x3				
C.Back Bar	QTY	N.W	G.W	C.B.M.	Size
Set	6	0.46kg	0.48kg	0.0004	55x10x810mm
10.491	Curved / Back 3x3				

Straight Bar	QTY	N.W	G.W	C.B.M.	Size
Set	12	0.83kg	0.85kg	0.008	55x20x750mm
10.716	Straight 4x3				
C.Front Bar	QTY	N.W	G.W	C.B.M.	Size
Set	12	0.78kg	0.8kg	0.0007	55x20x700mm
10.717	Curved / Front 4x3				
C.Back Bar	QTY	N.W	G.W	C.B.M.	Size
Set	8	0.6kg	0.62kg	0.0004	55x15x810mm
10.492	Curved / Back 4x3				

## Magnetic Bar

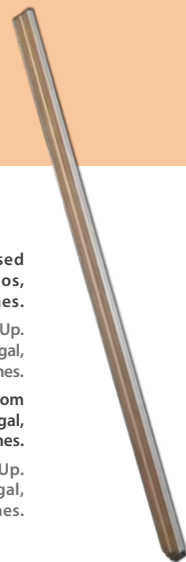

EN	Magnetic bar for Pop Up. Used with the models: Madrigal, Gredos, Arévalo, Laredo and Llanes.
FR	Barre magnétique pour Pop Up. Compatible avec les modèles: Madrigal, Gredos, Arevalo, Laredo et Llanes.
PT	Barra magnética compatível com os modelos Pop Up: Madrigal, Gredos, Arevalo, Laredo, Llanes.
ES	Barra magnética para Pop Up. Válida para los modelos: Madrigal, Gredos, Arévalo, Laredo y Llanes.

Mag.Bar	QTY	N.W	G.W	C.B.M.	Size
Packing	1	0.2kg	0.22kg	0.0003	50x10x760mm
10.419	720mm				

## Pop Up Connecting Pieces



### Plastic Piece for Magnetic Bar

PieceMag	QTY	N.W	G.W	C.B.M.	Size
Packing	1	0.014kg	0.015kg	0.00002	50x10x50mm
10.858	50x50x10mm				

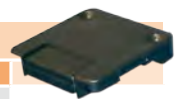

### Pop Up Corner

Corner	QTY	N.W	G.W	C.B.M.	Size
Packing	1	0.038kg	0.039kg	0.00007	50x30x50mm
10.409	50x50x20mm				



### Plastic Piece for Bar Graphics

Piece Bar	QTY	N.W	G.W	C.B.M.	Size
Packing	1	0.02kg	0.021kg	0.00006	55x20x60mm
10.859	60x50x10mm				



## Cross for Pop Up

Cross	QTY	N.W	G.W	C.B.M.	Size
Packing	1	0.70kg	0.80kg	0.005	80x80x800mm
10.897					



# Display Accessories

Pop Up PVC Pannel | Magnetic Strip Roll | Graphic Case 

## Pop Up PVC Pannel



- EN PVC pannel for Pop Up.
- FR Panneau en PVC pour Pop Up.
- PT Painel de PVC para Pop Up.
- ES Panel de PVC para Pop Up.

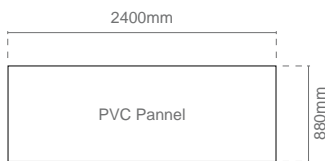

PVC Pannel	QTY	N.W	G.W	C.B.M.	Size
Packing	1	1.15kg	2.5kg	0.015	130x130x890mm
10.101		2400x880x0.4mm			

## Magnetic Strip Roll 12mm



- EN Magnetic strip roll, 50 metres length for fixing Pop Up graphics.
- FR Rouleau magnétique de 50m pour la fixation des images au Pop Up.
- PT Rolo magnético com 50 metros para fixar impressões de Pop Up.
- ES Rollo de imán de 50 metros para la fijación de gráficas de Pop Up.

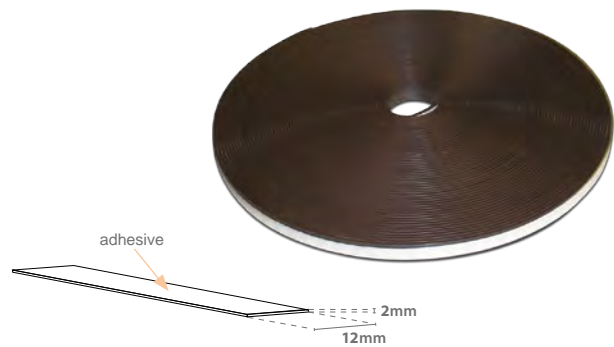



Magnet Roll	QTY	N.W	G.W	C.B.M.	Size
Packing	1	9kg	9.50kg	0.0044	420x25x420mm
10.360		50m x12mm			

## Graphic Case



- EN Graphic case, adjustable in height and portable, made of PVC. Ideal for transporting graphics or displays.
- FR Porte-visuel, télescopique et portable, fabriqué en PVC. Idéal pour le transport d'images ou de displays.
- PT Tubo para impressões extensível e portátil, fabricado em PVC. Ideal para o transporte de impressões ou displays.
- ES Porta-Gráficas extensible, realizado en PVC. Ideal para el transporte de gráficas o de displays. Disponible en dos colores y tres tamaños.

Graph. Case	QTY	N.W	G.W	C.B.M.	Size
Uni.	1	0.4kg	0.42kg	0.006	100x100x640mm
10.074		Ø107mm 640-1070mm			
10.075					
Graph. Case	QTY	N.W	G.W	C.B.M.	Size
Uni.	1	0.5kg	0.52kg	0.008	100x100x780mm
10.076		Ø107mm 779-1280mm			
10.077					
Graph. Case	QTY	N.W	G.W	C.B.M.	Size
Uni.	1	0.3kg	0.32kg	0.004	80x60x630mm
10.078		Ø85mm 630-1070mm			
10.079					



# Display Accessories

Roll Up Spotlights   

## Roll Up Spotlight



- EN Spotlight for Roll Up.
- FR Foyer d'éclairage pour Roll Up.
- PT Foco de Iluminação para Roll Up.
- ES Foco de iluminación para Roll up.



Spotlight 1	QTY	N.W	G.W	C.B.M.	Size	
Uni.	1	0.30kg	0.35kg	0.0016	125x65x200mm	
10.525			60 W			

## Roll Up Spotlight





## Roll Up Spotlight



- EN Spotlights for Roll Up. Bulb type Halogen (included) and directional head, large luminous capacity. Spotlight works directly plugged in.
- FR Foyer d'éclairage pour RollUp. Halogène (incluse avec tête orientable, grande capacité d'éclairage. Se branche directement sur le secteur.

- PT Focos de iluminação ideal para Roll Up. Cabeça direcional .Inclui cabo com ficha para ligação à tomada e lâmpada.
- ES Focos de iluminación para Roll Up. Bombilla halógena (incluida) y cabeza direccional. Funciona a corriente. Gran capacidad luminosa.



Spotlight 2	QTY	N.W	G.W	C.B.M.	Size	
Uni.	1	0.30kg	0.40kg	0.025	80x70x460mm	
10.055				50 W		
10.056						

Spotlight 3	QTY	N.W	G.W	C.B.M.	Size	
Uni.	1	0.30kg	0.35kg	0.002	100x70x400mm	
10.057				50 W		
13.401						

# Display Accessories

Roll Up LED Spotlight | Pop Up Spotlights



## Roll Up LED Clamp Spotlight

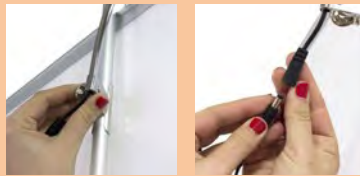

- EN LED light clamp for Roll Up. Works directly plugged in.
- FR Foyer d'éclairage à LED pour Roll Up. Se branche directement sur le secteur.
- PT Foco de Iluminação para Roll Up. LED. Inclui cabo com ficha para ligação à tomada e lâmpada.
- ES Foco de luz tipo LED para Roll Up. Funciona directamente a corriente.

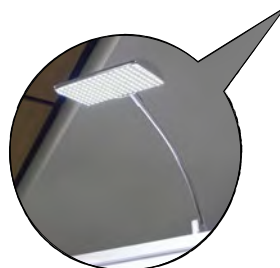

12w LED

LED RollUp	QTY	N.W	G.W	C.B.M.	Size	LED
Uni.	1	0.4kg	0.8kg	0.038	150x50x510mm	LED
10.687					12 W	

## Pop Up Spotlight



## Pop Up LED Spotlight



- EN Spotlight for Pop Up promotional support. Works directly plugged in. Black finishing.
- FR Foyer d'éclairage pour supports Pop Up. Se branche directement sur le secteur. En noir.
- PT Foco de iluminação para Pop Up. Inclui cabo com ficha para ligação à tomada e lâmpada.
- ES Foco de iluminación ideal para soportes Pop Up. Funciona a corriente. Acabado en negro.

- EN Led spotlight for Pop Up promotional supports. Works plugged in. With black finishing.
- FR Foyer d'éclairage à LED pour Pop Up. Se branche directement sur le secteur. Finition en noir.
- PT Foco com LED e pinça para Pop Up. Inclui cabo com ficha para ligação à tomada e lâmpada.
- ES Foco de iluminación LED para Pop Up. Funciona a corriente. Acabado en negro.



base con  
doble abrazadera



12w LED

base con  
doble abrazadera



PopUp Spot	QTY	N.W	G.W	C.B.M.	Size
Packing	1	0.65kg	0.7kg	0.038	150x50x510mm
10.368					150 W

LED PopUp	QTY	N.W	G.W	C.B.M.	Size	LED
Packing	1	0.45kg	0.85kg	0.038	150x50x510mm	LED
10.688					12 W	

EN

Special Aluminium System profiles for fabrics. Profiles available in standard or linear meters. The fabric should be sewn to a "strip" of silicone around its perimeter, then it is inserted into the insertion of the grid being tight and perfectly framed.

FR

Profil spécial en aluminium pour textile. Les profils sont fournis en formats standard ou en barre. Facile et rapide à assembler. Le textile se coud sur une « bande de silicone », qui va s'introduire dans la rainure du profil ce qui permet un visuel parfaitement présenté, tendu et encadré.

PT

Perfil especial em alumínio para impressão digital em têxtil. Montagem fácil e rápida. Os perfis são fornecidos em medidas estandarizadas ou por metro linear, para adequar ao espaço requerido. O tecido deve ser cosido a uma tira de silicone, que posteriormente será introduzida na ranhura do perfil de modo a ficar tenso e perfeitamente colocado.

ES

Sistema de perfilera de aluminio especial para tejidos. Los perfiles se suministran en medidas estándar o por metros lineales. El tejido es cosido a una "tira" de silicona en todo su perímetro, posteriormente se introduce en la inserción de la perfilera quedando tensada y perfectamente enmarcada.



fácil y rápido montaje

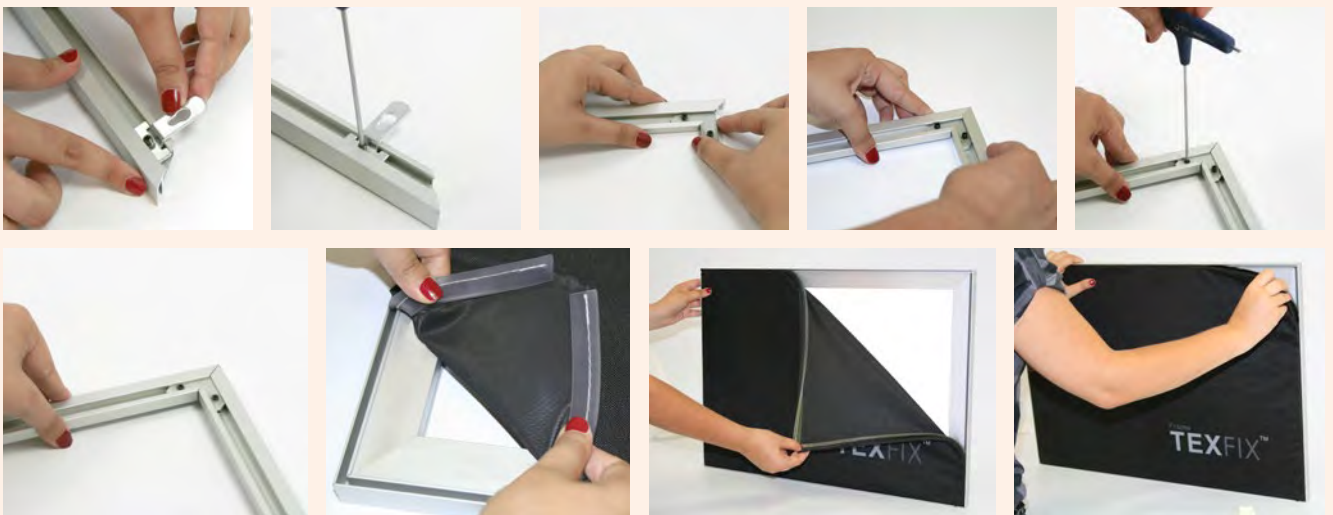
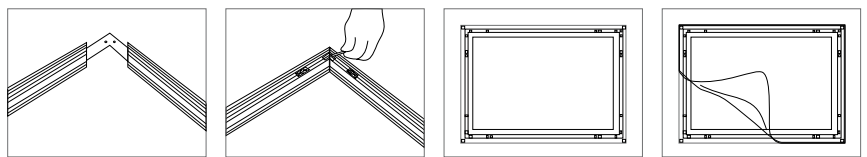
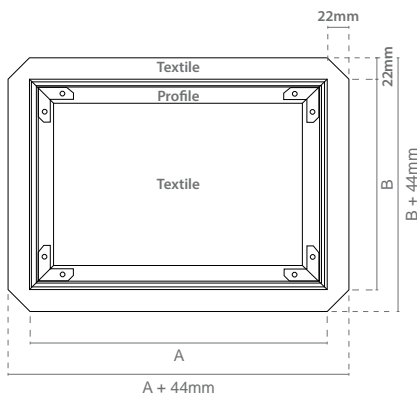

### TexFix Frame 16mm







rápido y fácil

- EN Includes: 4 simple aluminium profiles, 4 corners and 1 Allen key type. (Optional hangers).
- FR 4 profils simples, 4 équerres et 1 clef Allen inclus. Crochets vendus séparément.
- PT Inclui 4 perfis simples, 4 esquinas e 1 chave tipo Allen (suspensão opcional).
- ES Incluye 4 perfiles simples, 4 esquineros y 1 llave tipo Allen. Colgadores opcionales.



Colgadores  
opcionales



TexFix 16	Size		
13.132	A4		
13.133	A3		
13.134	A2		
13.135	A1		T
13.136	500x700mm		T
13.137	700x1000mm		T
13.138	500x1000mm		T

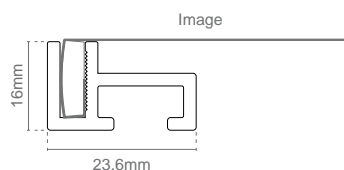

- T EN Fixing on the wall with screws in these sizes.
- FR Fixer avec des vises pour toutes les tailles.
- PT Fixar à parede seguindo as medidas indicadas.
- ES Fijar con tornillos a la pared en estas medidas.

### Aluminium Profile by Meters



- EN Profile in linear meters includes 4 units with 3m length each. Total 12m.
- FR Profil disponible au mètre linéaire. Inclus 4 barres de 3 mètres. Total 12m.
- PT Perfil vendido ao metro linear. Inclui 4 perfis de 3m. Total: 12m.
- ES Perfil disponible en metros lineales. Incluye 4 perfiles de 3m. Total 12m.

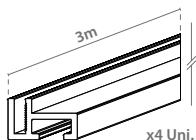

- EN Corner connector.
- FR Connexion d'angle.
- PT Esquina.
- ES Esquinero.



T.Fix16   m	Size		
13.139	 4 uni. x 3m/l=12m/l		

Corner 16mm			
13.171	x20		



### TexFix Wall Frame 27.5mm



fácil  
montaje

- EN Simple aluminum frame profile for textile digital printing. Special for free spaces on walls. Easy and quick to assemble.
- FR Profil simple en aluminium pour des impressions digitales en textile et de montage facile. Idéal pour combler des espaces vides.
- PT Perfil simples de alumínio para elaboração de molduras que permitem a colocação de impressões têxteis digitais. De fácil e rápida montagem. Ideal para cavidades nas paredes.
- ES Perfil simple de aluminio para colocación en huecos y espacios libres en muros. Montaje fácil y rápido. Impresión sobre textil.



- EN Profile in linear meters, includes 4 units with 3m lengths. Total 12m.
- FR Profil au mètre linéaire. Inclus 4 barres de 3 mètres. Total 12m.
- PT Perfil vendido ao metro linear. Inclui 4 perfis de 3m. Total: 12m.
- ES Perfil en metros lineales. Incluye 4 perfiles de 3m. Total: 12m.

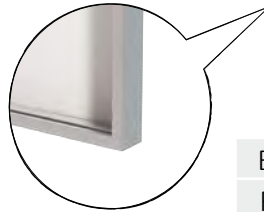
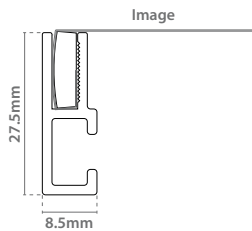

- EN Corner connector.
- FR Connexion d'angle.
- PT Esquina.
- ES Esquinero.



T.Fix27.5   m	QTY	N.W	G.W	C.B.M.	Size
Packing	4	2.45kg	2.85kg	0.0147	75x65x3015mm
13.157	4 uni. x 3m/l=12m/l				

Corner 27.5	
13.243	x20





### TexFix Frame 41.5x16mm Double-Sided

- EN** Double-sided aluminum frame profile for textile digital printing. Used with feet to be placed on a floor. Standard sizes. The item includes: 4 Profiles, 4 corners and 1 Allen key type.
- FR** Profil double en aluminium pour des impressions digitales sur textile. Avec socle pour une utilisation au sol. Tailles préconisées. 4 profils, 4 équerres et 1 clef Allen inclus.
- PT** Perfil dupla face em alumínio para a elaboração de molduras que permitem a colocação de impressões têxteis digitais. Usado em conjunto com pés que vão permitir a sua colocação no solo. Tamanhos estandardizados. Inclui 4 perfis, 4 esquinas e 1 chave tipo Allen.
- ES** Perfil doble para la elaboración de marcos de aluminio mediante impresión digital sobre textil. Medidas estandar. Incluye: 4 perfiles, 4 esquineros y 1 llave tipo Allen.

Ref.13.170

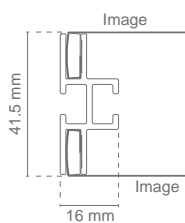

Includes:



T.Fix 41.5x16	Size
13.158	A4
13.159	A3
13.160	A2
13.161	A1

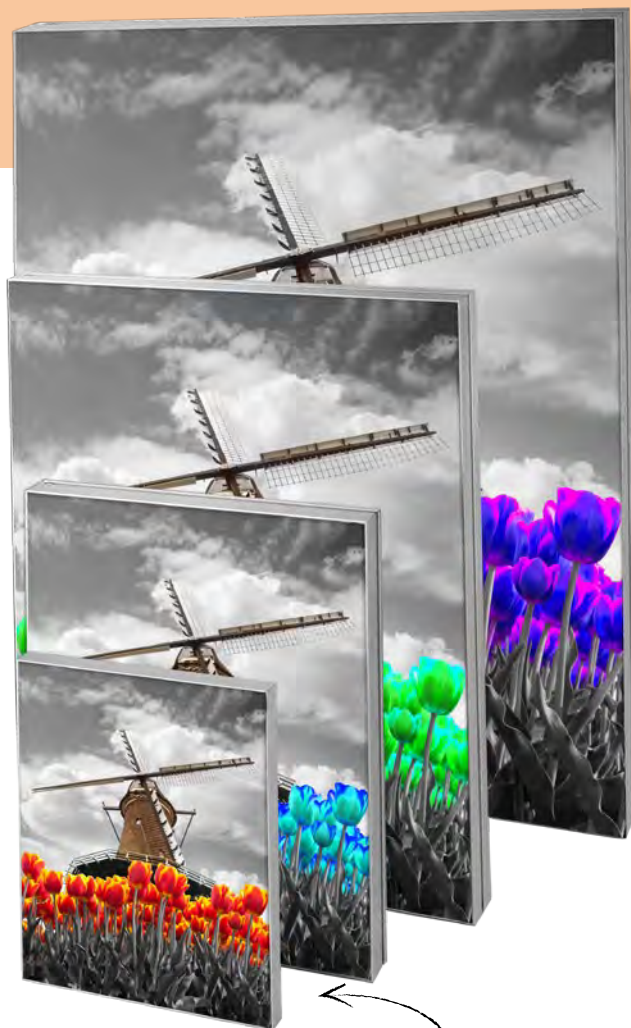

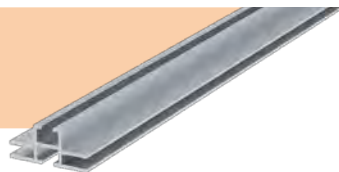

doble cara

### Aluminium Profile by Meters

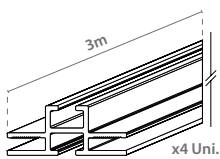

- EN** Profile in linear meters includes 4 units with 3m length each. Total 12m.
- FR** Profil disponible au mètre linéaire. Inclus 4 barres de 3 mètres. Total 12m.
- PT** Perfil vendido ao metro linear. Inclui 4 perfis de 3m. Total: 12m.
- ES** Perfil disponible en metros lineales. Incluye 4 perfiles de 3m. Total 12m.



T.Fix.41.5   m	QTY	N.W	G.W	C.B.M.	Size
Packing	4	4.66kg	5.11kg	0.0147	75x65x3015mm
13.170		4 uni. x 3m/l=12m/l			

### Corner Connector



- EN** Corner connector.
- FR** Connexion d'angle.
- PT** Esquina.
- ES** Esquinero.

Corner 41.5	
13.243	x20 

### TexFix Frame 41.3x38.1mm Double-Sided

rápido  
montaje

EN	Double-sided aluminum frame profile for textile digital printing. Used with feet to be placed on a floor. Standard sizes. The item includes: 4 Profiles, 4 corners and 1 Allen key type. Feet not included.
FR	Profil double en aluminium pour des impressions digitales en textile. Avec socle pour une utilisation au sol. Tailles préconisées. 4 profils, 4 équerres et 1 clef Allen inclus. Socles non inclus.
PT	Perfil dupla face em alumínio para a elaboração de molduras que permitem a colocação de impressões têxteis digitais. Usado em conjunto com pés que vão permitir a sua colocação no solo. Tamanhos estandardizados. Inclui 4 perfis, 4 esquinhas e 1 chave tipo Allen. Pés não incluídos.
ES	Perfil doble para la elaboración de marcos de aluminio mediante impresión digital sobre textil. Medidas estandar. Incluye: 4 perfiles, 4 esquineros y 1 llave tipo Allen. Patas no incluidas.

doble  
cara

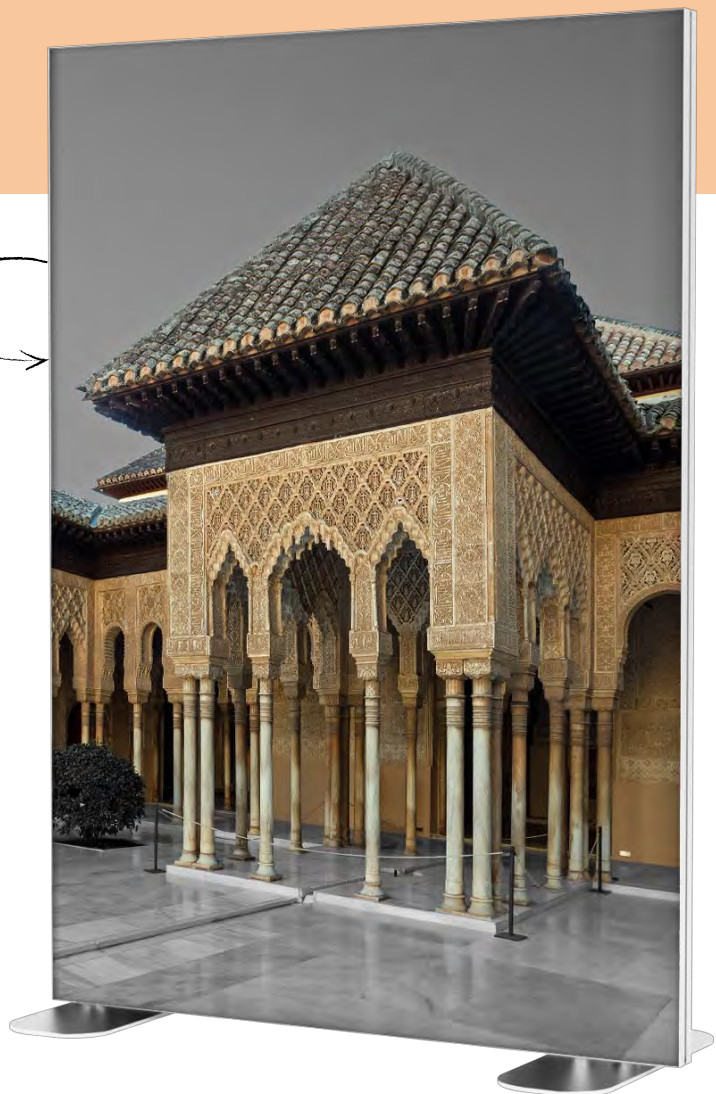
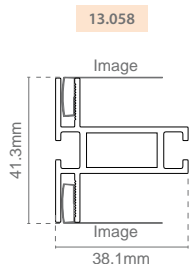

TF 41.3x38.1	Graphic Size
13.163	500x700mm
13.166	500x1000mm
13.164	700x1000mm
13.162	A0
13.167	1000x1000mm
13.165	1000x1400mm
13.168	1000x1500mm
13.282	700x2000mm
13.169	1000x2000mm

Includes:

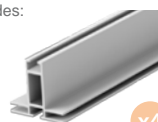

### Aluminium Profile by Meters

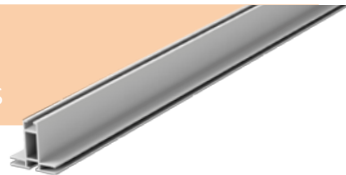

EN	Profile in linear meters includes 4 units with 3m length each. Total 12m.
FR	Profil disponible au mètre linéaire. Inclus 4 barres de 3 mètres. Total 12m.
PT	Perfil vendido ao metro linear. Inclui 4 perfis de 3m. Total: 12m.
ES	Perfil disponible en metros lineales. Incluye 4 perfiles de 3m. Total 12m.

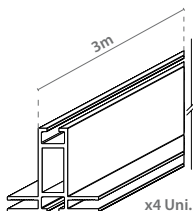

### Corner Connector



EN	Corner connector.
FR	Connexion d'angle.
PT	Esquina.
ES	Esquinero.

TF41.3x38.1 m	Size
13.058	 4 uni. x 3m/l=12m/l

Corner 41.3	Size
13.243	x20 

## Double-Sided Frame Profile





### TexFix Frame 100x20.5mm Double-Sided



- EN Double-sided aluminum frame profile for textile digital printing Standard sizes. The base feet and accessories are not included.
- FR Profil double en aluminium pour des impressions digitales sur textile. Tailles préconisées. Accessoires non inclus. Socle non inclus.
- PT Perfil dupla face em alumínio para a elaboração de molduras que permitem a colocação de impressões têxteis digitais. Tamanhos estandarizados. Pés e acessórios não incluídos.
- ES Perfil doble para la elaboración de marcos de aluminio mediante impresión digital sobre textil. Medidas estandar. Patas no incluidas.



\* The ends are mitred / Couper en biais à 45° / Corte en esquadria de 45° / Cortado al inglete.

TF 100x20.5	Size		
13.300	500mm	x2	
13.301	1000mm	x2	
13.302	1500mm	x2	
13.303	2000mm	x2	
13.304	2500mm	x2	
13.305	3000mm	x2	

doble  
Cara

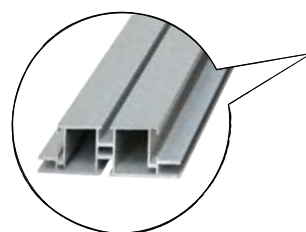
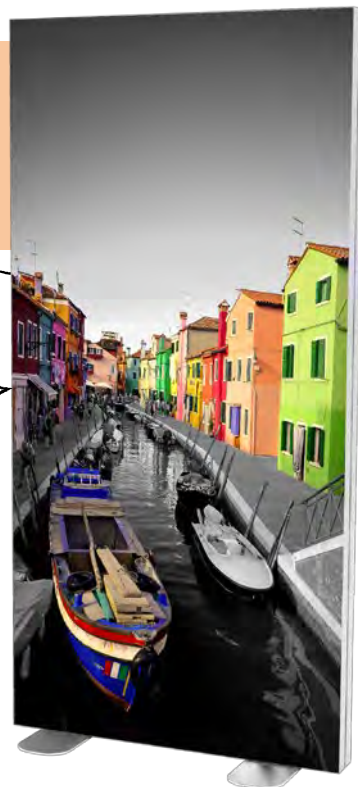
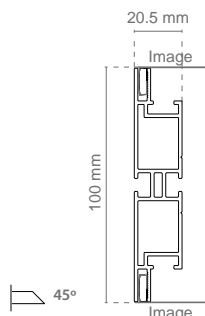





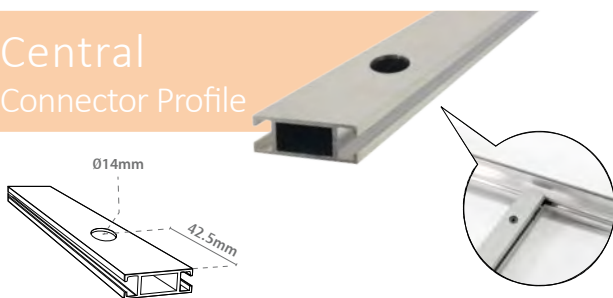

x2



### Central Connector Profile



Central	Size		
13.342	600mm	x2	
13.343	700mm	x2	
13.344	1000mm	x2	
13.345	1500mm	x2	
13.346	2000mm	x2	
13.347	2500mm	x2	
13.348	3000mm	x2	

also linear meters available:

Central	QTY	N.W	G.W	C.B.M.	Size
Packing	4	5.05kg	5.40kg	0.0147	75x65x3020mm
13.246	 4 uni. x3m/l=12m/l				

### Corner Connection



Corner	QTY	N.W	G.W	C.B.M.	Size
Packing	20	0.66kg	0.85kg	0.0005	75x75x90mm
13.333	x20 				

### Lock

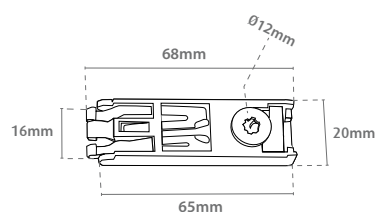

Lock	
13.244	

## Fast TexFix



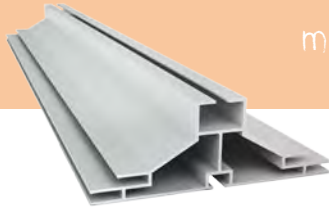

rápido montaje

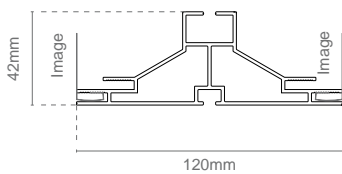

- EN Aluminum frame profile for textile digital printing.
- FR Profil en aluminium pour des impressions digitales en textile.
- PT Perfil em alumínio que permitem a colocação de impressões têxteis digitais.
- ES Perfil de aluminio para la elaboración de marcos mediante impresión digital sobre textil.

perfil 120 mm



Fast TexFix	Size	
13.492	500mm	x2 
13.491	1000mm	x2 
13.490	2000mm	x2 
13.489	3000mm	x2 

## Fast Corner Connector

rápido y fácil montaje



- EN Corner connector.
- FR Connexion d'angle.
- PT Esquina.
- ES Esquinero.

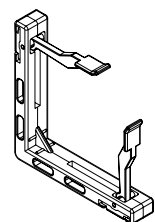
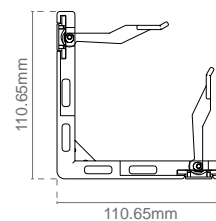
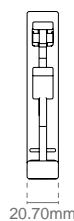
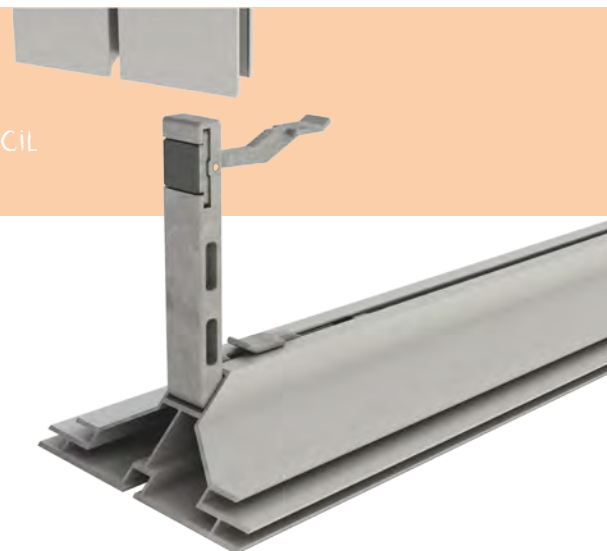

Fast Corner		
13.493	x4 	

# TexFix Light

TexFix Light Complete KITS



Complete KITS  
TexFix Frame 100x20.5mm  
Double-Sided with Light

bajo  
consumo  
de energía



doble  
Cara

rápido y  
fácil montaje



superb  
iluminación

ideal para  
usar Como:

señalización  
retro iluminada

totem Luminoso

divisores

Muro Luminoso



Consúltenos sobre todas las posibilidades que le ofrecen los productos de la serie TexFix

# TexFix Light

TexFix Light Complete KITS



	600mm	700mm	1000mm	1500mm
600mm				
	LED 500 x1 Uni.	LED 500 x1 Uni. Use in 600mm side	LED 500 x1 Uni. Use in 600mm side	LED 500 x2 Uni. Use in 600mm sides
	Pw. 60W/24V x1 Uni.	Pw. 60W/24V x1 Uni.	Pw. 60W/24V x1 Uni.	Pw. 60W/24V x1 Uni.
	<b>13.308</b>	<b>13.309</b>	<b>13.310</b>	<b>13.311</b>
700mm				
	LED 500 x1 Uni.	LED 500 x1 Uni. Use in 700mm side	LED 500 x2 Uni. Use in 700mm sides	
	Pw. 60W/24V x1 Uni.	Pw. 60W/24V x1 Uni.	Pw. 60W/24V x1 Uni.	
	<b>13.315</b>	<b>13.316</b>	<b>13.317</b>	
1000mm				
	LED 500 x1 Uni.   LED 300 x1 Uni.	LED 500 x2 Uni.   LED 300 x1 Uni.		
	Pw. 60W/24V x1 Uni. Use in 1000mm sides	Pw. 60W/24V x1 Uni. Use in 1500mm sides		
	<b>13.321</b>	<b>13.322</b>		
1500mm				
	LED 500 x4 Uni.   LED 300 x2 Uni.			
	Pw. 100W/24V x1 Uni. Use in 1500mm sides			
	<b>13.326</b>			
<p>Consúltenos sobre todas las posibilidades que le ofrecen los productos de la serie TexFix</p>				

# TexFix Light

TexFix Light Complete KITS

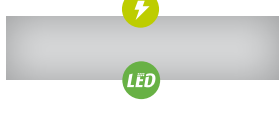
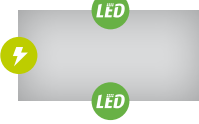

2000mm		2500mm		3000mm		
						600mm
LED 300 x1 Uni. + LED 500 x3 Uni. Use in 2000mm sides		LED 500 x3 Uni.   LED 300 x2 Uni. Use in 2500mm sides		LED 500 x4 Uni.   LED 300 x2 Uni. Use in 3000mm sides		
Pw. 100W/24V x1 Uni.	1 x Transverse Reincorc.	Pw. 60W/24V x1 Uni.	1 x Transverse Reincorc.	Pw. 100W/24V x1 Uni.	2 x Transverse Reincorc.	
<b>13.312</b>		<b>13.313</b>		<b>13.314</b>		
						700mm
LED 300 x1 Uni. + LED 500 x3 Uni. Use in 2000mm sides		LED 500 x3 Uni.   LED 300 x2 Uni. Use in 2500mm sides		LED 500 x4 Uni.   LED 300 x2 Uni. Use in 3000mm sides		
Pw. 100W/24V x1 Uni.	1 x Transverse Reincorc.	Pw. 60W/24V x1 Uni.	1 x Transverse Reincorc.	Pw. 100W/24V x1 Uni.	2 x Transverse Reincorc.	
<b>13.318</b>		<b>13.319</b>		<b>13.320</b>		
						1000mm
LED 500 x6 Uni. + LED 300 x2 Uni. Use in 2000mm sides		LED 500 x6 Uni.   LED 300 x4 Uni. Use in 2500mm sides		LED 500 x8 Uni.   LED 300 x4 Uni. Use in 3000mm sides		
Pw.150W/24V x1 Uni.	1 x Transverse Reincorc.	Pw. 150W/24V x1 Uni.	1 x Transverse Reincorc.	Pw. 200W/24V x1 Uni.	2 x Transverse Reincorc.	
<b>13.323</b>		<b>13.324</b>		<b>13.325</b>		
						1500mm
LED 500 x6 Uni.   LED 300 x2 Uni. Use in 2000mm sides		LED 500 x6 Uni.   LED 300 x4 Uni. Use in 2500mm sides		LED 500 x8 Uni.   LED 300 x4 Uni. Use in 3000mm sides		
Pw. 150W/24V x1 Uni.	1 x Transverse Reincorc.	Pw. 150W/24V x1 Uni.	1t x Transverse Reincorc.	Pw. 200W/24V x1 Uni.	2 x Transverse Reincorc.	
<b>13.327</b>		<b>13.328</b>		<b>13.329</b>		



# TexFix Light

TexFix Light    

## TexFix Light Ultra Slim



- EN Single aluminum frame profile with LEDs. Easy and quick to assemble.
- FR Profil, simple face, lumineux en aluminium. Facile à assembler.
- PT Perfil simples para moldura com LEDs. De fácil e rápida montagem. Alumínio.
- ES Perfil simple de aluminio con sistema de LEDs. De fácil y rápido montaje.

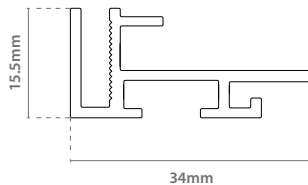

\* Other sizes available upon request / Disponible autres des tailles par demande  
Outras medidas mediante consulta / Otras medidas disponibles bajo consulta.

TF UltraSlim	Graphic Size
13.180	A4
13.179	A3
13.178	A2
13.177	A1
13.176	A0
13.306	500x700mm
13.307	700x1000mm

15.5 mm  
de grosor





# TexFix Light

Double-Sided Frame Profile with Light



TexFix Frame  
100x20.5mm  
Double-Sided with Light



**EN** Double Aluminum Profile for light frame using digital printing textile. Used with feet to be placed on the floor. Prices for complete kit.

**FR** Profil lumineux double face en aluminium pour des impressions digitales sur textile. Avec socle pour une utilisation au sol.

**PT** Perfil duplo para a elaboração de molduras de alumínio com luz para colocação de impressões digitais em têxtil. Utilizado com bases para poder ser colocado no chão. Preço para kit completo.

**ES** Perfil doble de aluminio con luz para impresiones digitales sobre textil. Utilizado con bases para colocarlo sobre el suelo. Precio por kit completo.

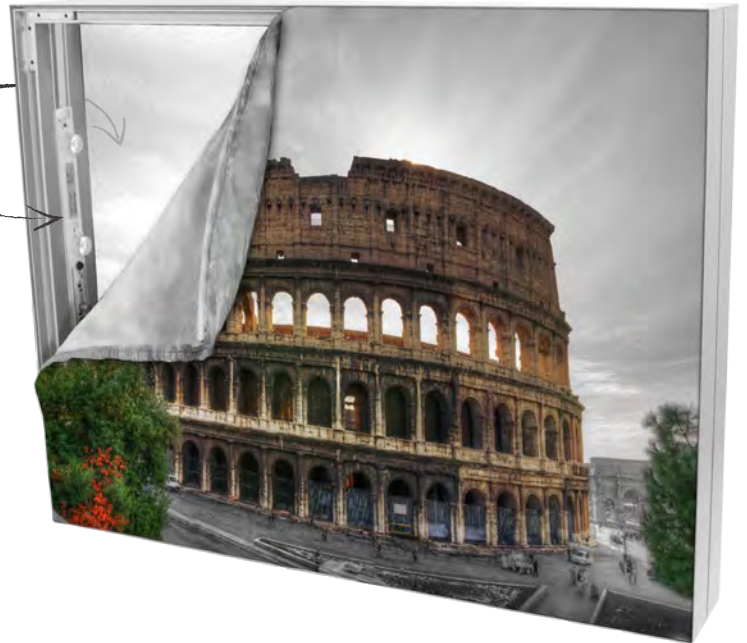
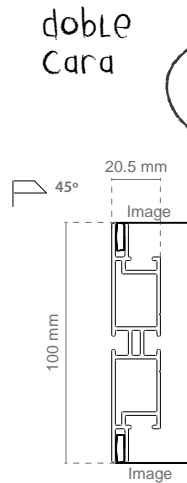

iluminado con sistema LED

Complete Kit includes



**1** Profiles & Corner Connections

x2

**2** LED Light System

**3** Central Connector Profile & Locks

Ø14mm  
42.5mm

**4** Tools & Accessories

\* Only included in required measures / Seulement inclus pour les dimensions requis  
Incluido somente nas medidas mencionadas / Includido sólo en medidas requeridas.

- Zinc screws.
- Cable with plug.
- 2.5mm Allen wrench.
- Electric clamp for cable.
- Easy grommet placement.
- Cable for internal connection.
- 4mm Allen wrench for locks (Only in required measures).

# TexFix Accessories

## TexFix Accessories

### Hangers TexFix Frame 16mm

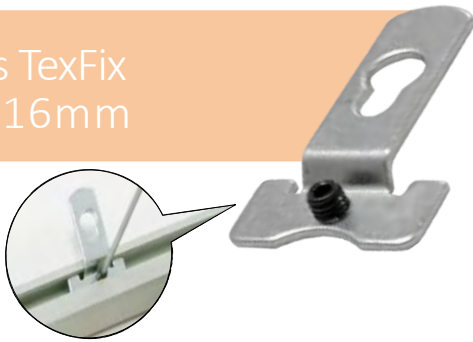

Hangers 16	QTY	N.W	G.W	C.B.M.	Size
Packing	20	0.31kg	0.45kg	0.0004	85x45x115mm
13.172				x20	

### Hangers

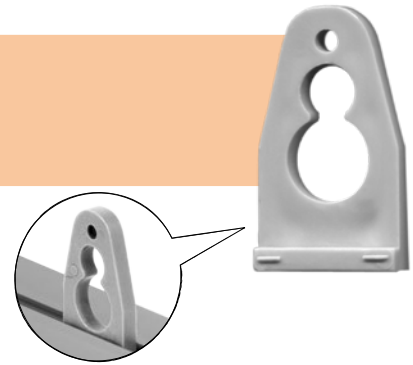

Hangers	QTY	N.W	G.W	C.B.M.	Size
Packing	10	0.047kg	0.01kg	0.00004	65x10x65mm
10.197				x10	

### Corner Connectors

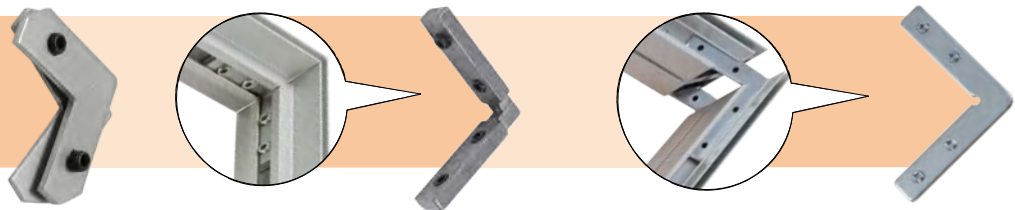

Corner 1	QTY	N.W	G.W	C.B.M.	Size
13.171				x20	

Corner 2	QTY	N.W	G.W	C.B.M.	Size
13.243				x20	

Corner 3	QTY	N.W	G.W	C.B.M.	Size
13.333				x20	

### Hangers Canvas

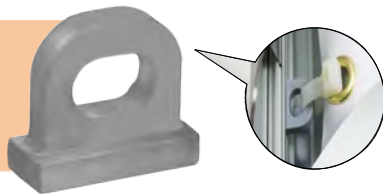

Hangers	QTY	N.W	G.W	C.B.M.	Size
13.334				x10	

### Silicone Strip



Silicone Strip	QTY	N.W	G.W	C.B.M.	Size
Packing	1	0.45kg	0.52kg	0.0021	100x80x265mm
13.173				10 mts./l	

### Central Connector Profile

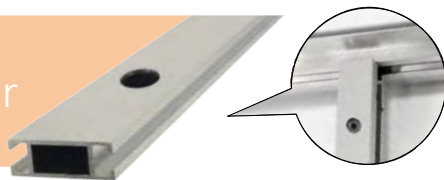

EN	Profile in linear meters includes 4 units with 3m length each. Total 12m.
FR	Profil vendu au mètre linéaire. Inclus 4 barres de 3 mètres. Total 12 mètres.
PT	Perfil ao metro linear. Inclui 4 perfis de 3metros. Total: 12metros.
ES	Perfil de aluminio en metros lineales. Incluye 4 perfiles de 3m. Total 12m.

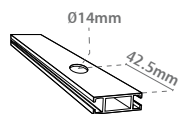

Central	QTY	N.W	G.W	C.B.M.	Size
Packing	4	5.05kg	5.40kg	0.0147	75x65x3020mm
13.246				4 uni. x3m/l=12m/l	

### Lock

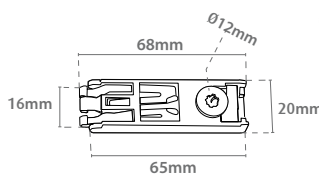

Lock	QTY	N.W	G.W	C.B.M.	Size
13.244					

# TexFix Accessories

TexFix Accessories 

Base Straight



improved stability

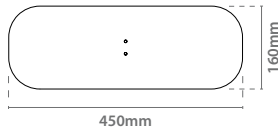

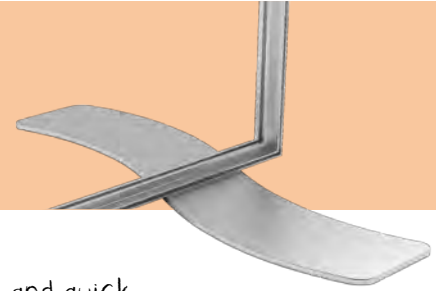

Base Stra.	QTY	N.W	G.W	C.B.M.	Size
Packing	1	5.9kg	6.1kg	0.0031	175x35x510mm
13.175	160x450mm		x2 		

Base 'S'

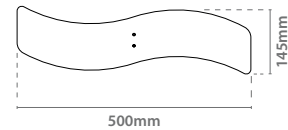

easy and quick assemble



Base 'S'	QTY	N.W	G.W	C.B.M.	Size
Packing	1	4.5kg	4.7kg	0.0031	175x35x510mm
13.174	145x500mm		x2 		

BowTie TexFix Base

**NEW**



\*included

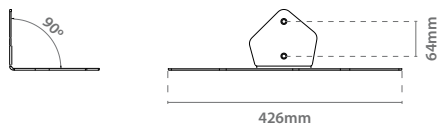

Bow Base	QTY	N.W	G.W	C.B.M.	Size
Packing	1	2.1kg	5.07kg	0.0143	521x200x137mm
13.474	Width: 426mm		x2 		

Fin TexFix Base

**NEW**



\*included

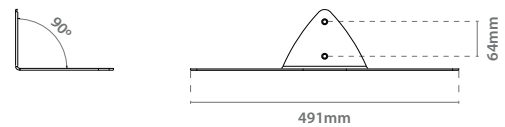

Fin Base	QTY	N.W	G.W	C.B.M.	Size
Packing	1	2.38kg	5.07kg	0.0143	521x200x137mm
13.480	Width: 491mm		x2 		

# Canvas TexFix

Canvas TexFix Big Sizes



## Canvas TexFix Light Profile (Big Sizes)

designed for large areas

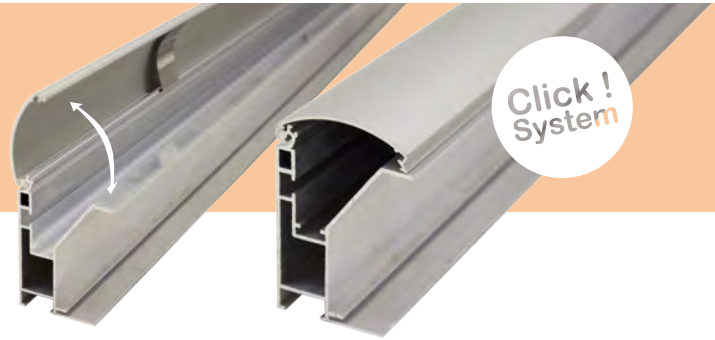

Click!  
System

EN	Aluminium profile with light system suitable for indoor assembly canvas. Specially designed for large areas.
FR	Profil en aluminium lumineux préconisé pour une utilisation à l'intérieure. Conçu pour des grandes surfaces.
PT	Sistema de perfil com luz adequado para lonas gigantes o grandes áreas. Exterior e interior.
ES	Sistema de perfil con luz adecuado para lonas gigantes o grandes áreas. Adecuado para exterior e interior.



available with LED light or without

\* Available upon request / Disponible sur demande  
Disponível por solicitação / Disponible bajo pedido.

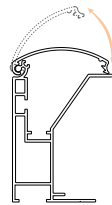
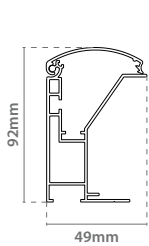

Click System



# Poster Display

PanelFix Wing | Multi-PanelFix Wing



## PanelFix Wing Steel

base made of steel

EN	Allows the fixing of supports up to 20 mm. The maximum recommended height for the graphic is 1500 mm. Allows the printing of any logo on both sides of the base.
FR	Permet l'utilisation de supports jusqu'à 20mm d'épaisseur. La hauteur maximale suggérée du visuel est de 1500mm. Possibilité d'inclure des logos sur les bases.
PT	Permite fixar painéis até 20 mm de espessura. A altura máxima recomendada é de 1500 mm. Permite a colocação de um logo em cada um dos lados da base.
ES	Permite la sujeción de soportes hasta 20mm. La altura máxima recomendada para la gráfica es de 1500mm. Permite la impresión de cualquier logo en ambos lados de la base.

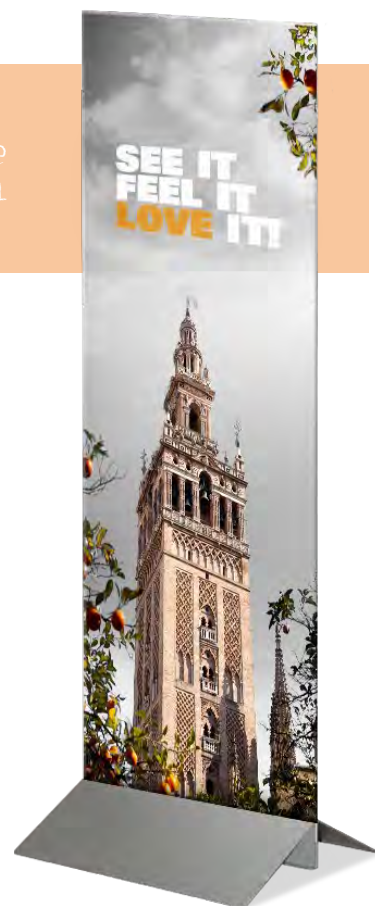
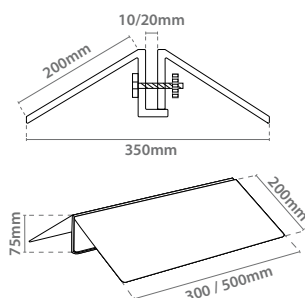

PanelFix 300	QTY	N.W	G.W	C.B.M.	Size
Packing	1	2.75kg	2.95kg	0.0069	210x100x330mm
10.065					300mm

PanelFix 500	QTY	N.W	G.W	C.B.M.	Size
Packing	1	4.55kg	4.85kg	0.011	210x100x530mm
10.066					500mm

## Multi-Panel Fix Wing

multipurpose steel base



anti deslizantes

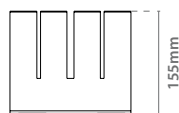
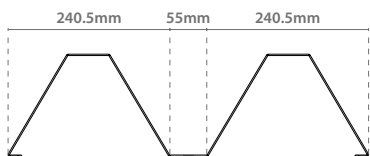

grosor de las separaciones

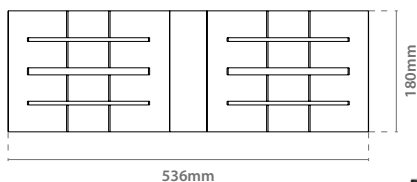
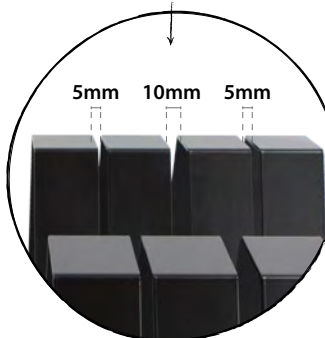

Multi Black	QTY	N.W	G.W	C.B.M.	Size
Packing	1	2.3kg	2.6kg	0.06	545x190x165mm
10.393		Black	536x155x180mm	x1	

Multi Grey	QTY	N.W	G.W	C.B.M.	Size
Packing	1	2.3kg	2.6kg	0.06	545x190x165mm
10.394		White	536x155x180mm	x1	

# Poster Display

PanelFix Wing  

## PanelFix Wing Aluminium



EN

Aluminium base support for the placement of rigid graphics. Depending of its placement, this can be used with graphic thickness of 3mm up to 26mm. Available in 3 different sizes, 200mm, 350mm and 550mm.

FR

Base en aluminium pour l'exposition de visuels rigides. En fonction de sa position, il permet le maintien de supports de 3mm à 26mm d'épaisseur. Disponible en 3 largeurs: 200mm, 350mm et 550mm.

PT

Base de alumínio para a colocação de impressões rígidas. Dependendo da posição pode ser utilizado com painéis dos 3 ao 26 mm. Disponível em três tamanhos diferentes: 200, 350 e 550 mm.

ES

Base de aluminio para la colocación de soportes gráficos rígidos. Dependiendo de su colocación, permite la sujeción de soportes de 3mm a 26mm de espesor. Disponible en 3 anchos, 200mm y 550mm.

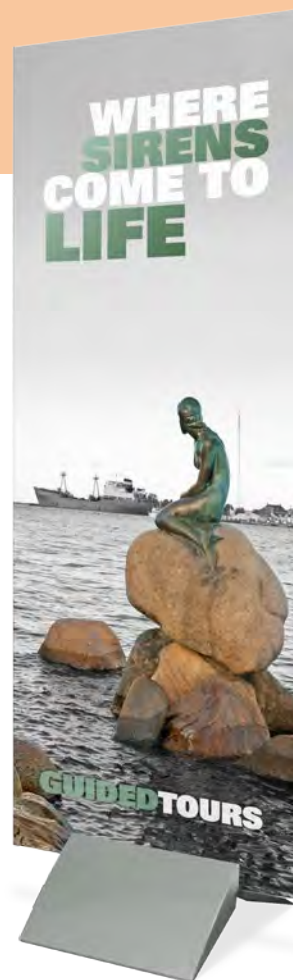
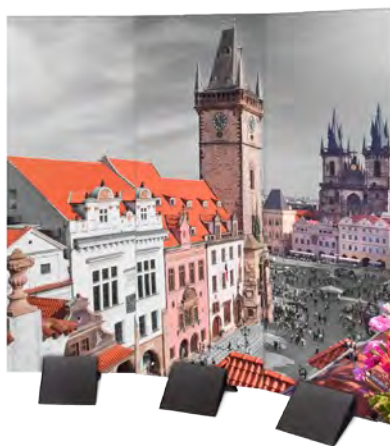
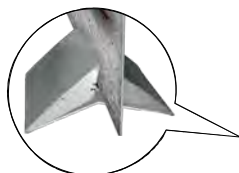

disponible en  
negro y plateado



EN

Installation for panels with thickness of 3-18mm.

FR

Installation pour un panneau de 3-18mm d'épaisseur.

PT

Instalação para um painel de 3 a 18mm de espessura.

ES

Instalación para un panel de grosor de 3-18mm.

EN

Installation for panels with thickness of 18-26mm.

FR

Installation pour un panneau de 18-26mm d'épaisseur.



PT



Instalação para um painel de 18 a 26mm de espessura.

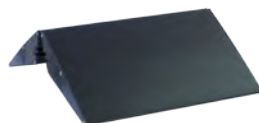
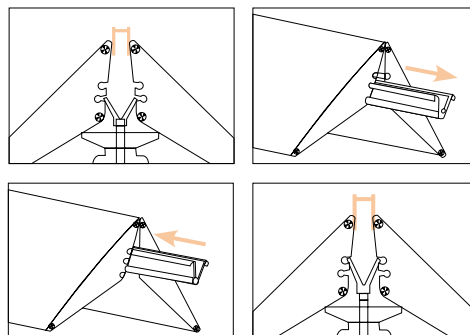
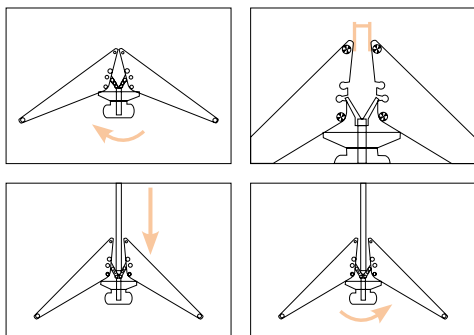

ES

Instalación para un panel de grosor de 18-26mm.



PF Alum 200	QTY	N.W	G.W	C.B.M.	Size
Packing	1	1.1kg	1.5kg	0.0069	315x93x235mm
10.828		200mm			
10.829					

PF Alum 350	QTY	N.W	G.W	C.B.M.	Size
Packing	1	2.6kg	3kg	0.0113	315x93x385mm
10.877		350mm			
10.869					

PF Alum 550	QTY	N.W	G.W	C.B.M.	Size
Packing	1	4.15kg	4.6kg	0.0171	315x93x585mm
10.880		550mm			
10.870					

# Poster Display

Poster Display  

## Montijo

10.838



10.898





- EN Steel support for the placement of graphics up to 10mm thickness. Sizes: 300mm diameter x 200mm high and x 6mm thickness.
- FR Base métallique ronde en acier de 6mm d'épaisseur, 300mm de diamètre et 200mm de hauteur. Idéal pour visuels en carton léger ou compacts ayant une épaisseur maximum de 10mm.
- PT Base metálica para colocar suportes rígidos, com 300mm de diâmetro e 200 mm de altura. Suporta impressões até 10 mm de espessura.
- ES Base de acero de 6mm de espesor. 300mm de diámetro y 200mm de alto. Ideal para colocación de gráficas de hasta 10mm de espesor.

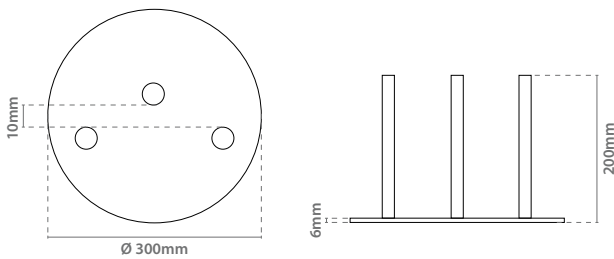

anti deslizantes



Montijo	QTY	N.W	G.W	C.B.M.	Size
Packing	2	7.2kg	7.75kg	0.024	310x250x310mm
10.898		Ø300mm		x2	
10.838					

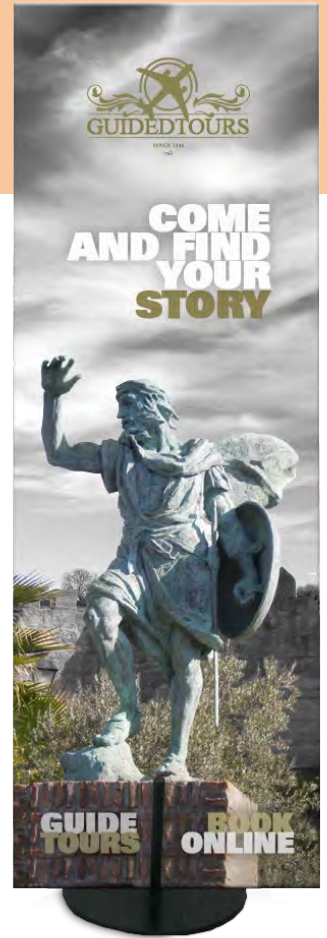

## Balboa

10.894

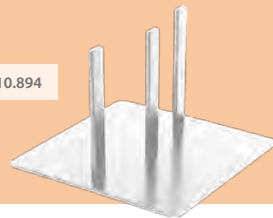

10.895





- EN Steel support for placement of graphics up to 11mm thickness. Sizes: 300mm diameter x 200mm high x 5mm thickness.
- FR Base de acier de 5mm d'épaisseur. Mesures: 295\*295mm et 200mm d'hauteur. Idéal pour l'exposition de visuels jusqu'à 11 mm d'épaisseur.
- PT Base metálica com 5mm de espessura. Medidas 295x295 mm e 200 mm de altura. Suporta impressões até 11 mm de espessura. Aço.
- ES Base de 5mm de espesor. Medidas 295x295mm y 200mm de alto. Ideal para colocación de soportes gráficos de hasta 11mm de espesor. Acero.

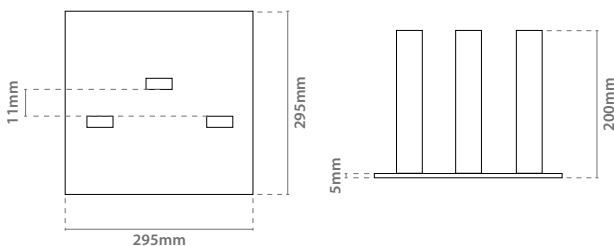

anti deslizantes



Balboa	QTY	N.W	G.W	C.B.M.	Size
Packing	2	9.00kg	9.60kg	0.024	310x250x310mm
10.894					
10.895		295x295mm	x2		

disponible en color negro y blanco



# Poster Display

PanelFix Wing Outdoor | Steel Display



## PanelFix Wing Outdoor

- EN Refillable plastic base for the placement of rigid graphics. Available in gray or black colour.
- FR Base en plastique à remplir d'eau pour l'affichage de visuels rigides. Disponible en gris ou en noir.
- PT Base de plástico que se pode encher com água. Disponível em preto ou cinzento.
- ES Base de plástico rellenable para la colocación de gráficos rígidos. Disponible en gris o negro.



relleno con 5 kg de agua o arena

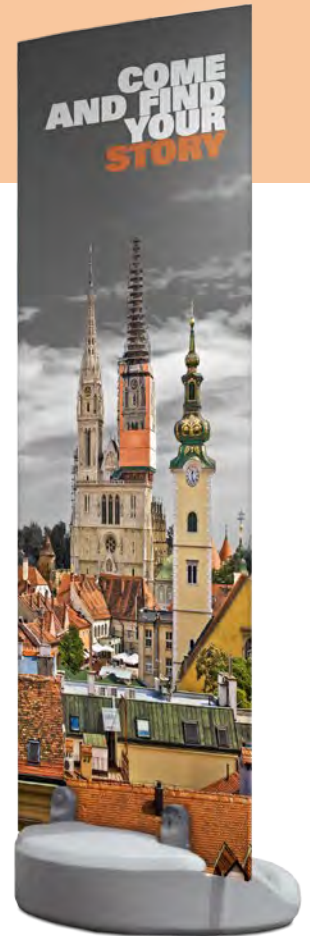
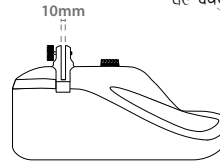

PF Wing Out	QTY	N.W	G.W	C.B.M.	Size
Packing	1	2kg	2.55kg	0.04	440x190x520mm
10.442					
10.443					

## Steel Display

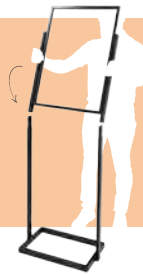

- EN Steel Display . Easy to assemble.
- FR Structure en acier, facile à assembler.



- PT Expositor em aço e de fácil montagem.
- ES Display fabricado en acero. Fácil de montar.

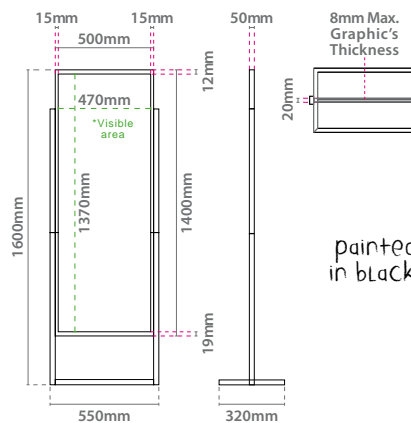
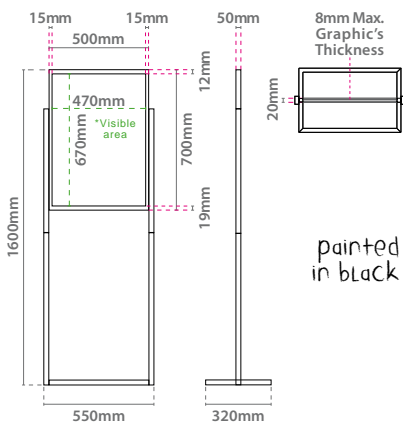

Steel D1	QTY	N.W	G.W	C.B.M.	Size
Packing	1	8.65kg	9.55kg	0.0459	570x100x805mm
10.996					

Steel D2	QTY	N.W	G.W	C.B.M.	Size
Packing	1	9.5kg	10.4kg	0.0459	570x100x805mm
10.997					



# Poster Display

Poster Display 

## Algora



EN Telescopic banner system. Adjustable height: 1000-1600mm.  
 FR Expositur métallique, réglable en hauteur: de 1000-1600mm.  
 PT Expositor ajustável em altura entre os 1000 e 1600 mm.  
 ES Expositor de metal, ajustable en altura, de 1000-1600mm.

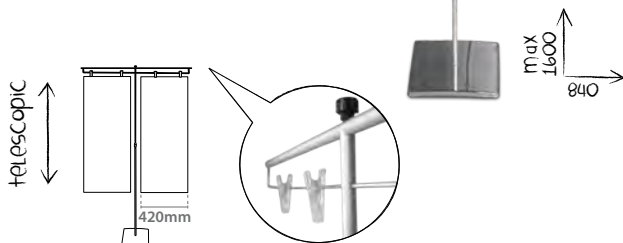

Algora	QTY	N.W	G.W	C.B.M.	Size
Packing	1	1.2kg	1.6kg	0.02	270x70x1200mm 
10.803		840x1000-1600mm			

## Oropesa

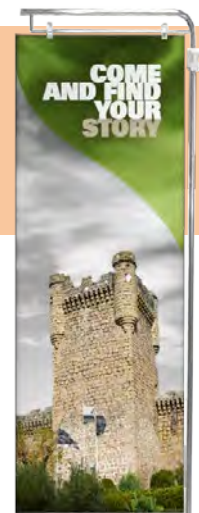

EN Telescopic banner system. Adjustable height: 1100-2100mm.  
 FR Expositur métallique, réglable en hauteur: de 1100-2100mm.  
 PT Expositor ajustável em altura entre os 1100 e 2100 mm.  
 ES Expositor de metal, ajustable en altura, de 1100-2100mm.

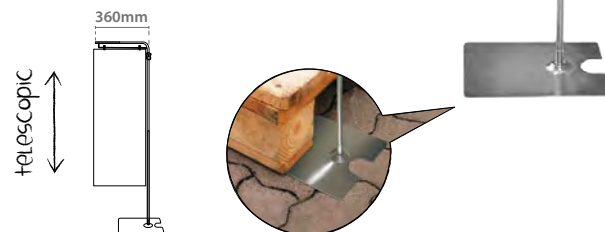

Oropesa	QTY	N.W	G.W	C.B.M.	Size
Packing	1	1.96kg	2.53kg	0.05	410x118x1185mm
10.432		360x1100-2100mm			

## Vilamoura Extension Banner



EN Telescopic banner system, with telescopic poles that permit to adjust the height and width of the graphics.  
 • Minimum graphic size: 945mm high x 1300mm wide.  
 • Maximum graphic size: 2330mm high x 2330mm wide.  
 FR Banner extensible, permettant différents tailles de visuel.  
 Facile à démonter et à transporter. Fabriqué en acier et plastique.  
 • Format minimum des visuels: 945mm hauteur x 1300mm largeur.  
 • Format maximum des visuels: 2330mm hauteur x 2330mm largeur.  
 PT Expositor ajustável em altura e comprimento. Fácil de guardar para um melhor transporte. Fabricado em aço e plástico.  
 • Área de impressão mínima: 945mm altura x 1300mm largura.  
 • Área de impressão máxima: 2330mm altura x 2330mm largura.  
 ES Banner extensible fabricado en acero pintado. Ideal para adaptarse a distintos tamaños de gráfica gracias a sus tubos telescópicos que permiten la extensión tanto horizontal como vertical.  
 • Área gráfica mínima: 945mm alto x 1300mm ancho.  
 • Área gráfica máxima: 2330mm alto x 2330mm ancho.



Vilamoura	QTY	N.W	G.W	C.B.M.	Size
Packing	1	6.6kg	8kg	0.027	240x115x1000mm 
10.498					

# Quick System

Quick System 

EN Quick System is great for the exhibition of products, displays and many different visual needs. Quick and easy assembly.

FR Système d'exhibition idéal pour l'exposition d'affiches, produits liés à la communication. Rapide et facile à monter.

PT Este sistema é ideal para exibição de produtos, imagens ou qualquer necessidade de comunicação. Montagem rápida e simples.

ES Sistema de exhibición ideal para exposición de carteles, productos y distintas necesidades de comunicación. Fácil y rápido montaje.

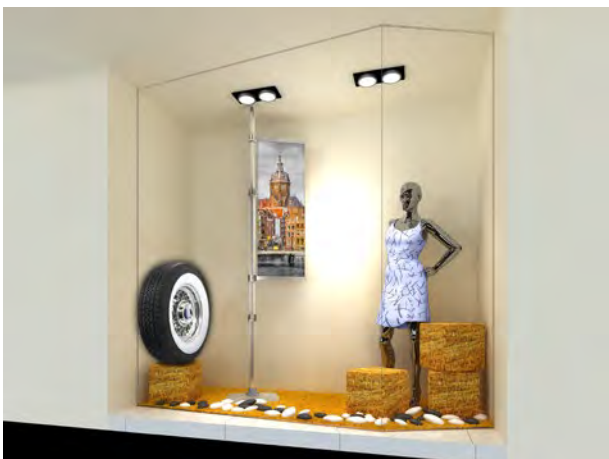



# Quick System

Quick System 

## Telescopic Pole

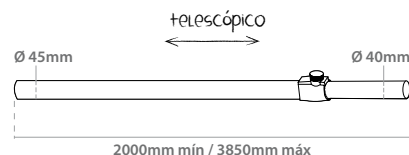
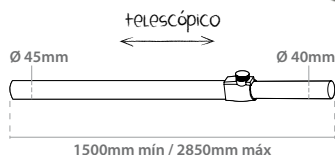
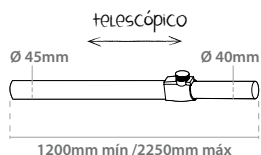
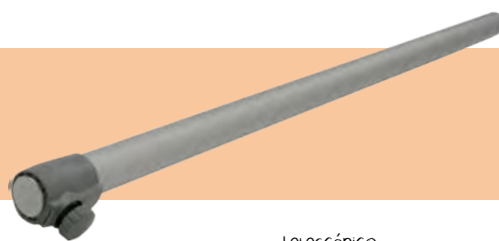
sistema mástil aluminio



Pole 1	
10.961	Ø 45x1200mm

Pole 2	
10.962	Ø 45x1500mm

Pole 3	
10.963	Ø 45x2000mm

## Pole's End Caps



End Caps	
10.966	x10 

## Base Connector

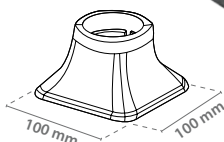

torneillos para la base

B.Connector	
10.967	

## Square Base



Square Base	
10.964	

## Feet Base



Feet Base	
10.965	

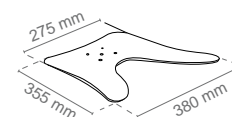

## 7 Ways Connector

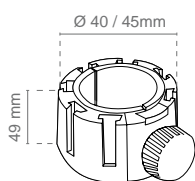

7 Ways Connector	
10.968 - 40	Ø 40mm
10.968 - 45	Ø 45mm



## Alu Block

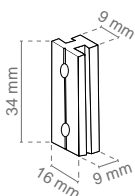

Alu Block	
10.969	x10 

## Rail

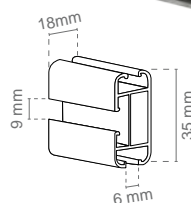
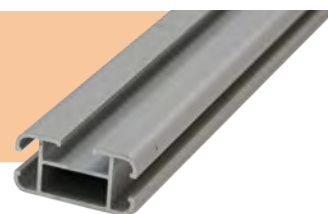

Rail	
10.970	2 meter

Combinalo con el resto de los accesorios

# Quick System

## Quick System

### PVC Insert

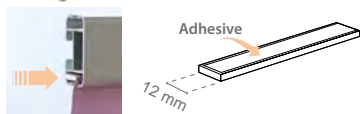

PVC Insert

10.862

2 meter

pegarlo al  
pvc

### Side Connecting Block

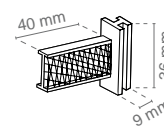
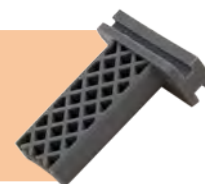

Side Con.

10.863

x10

conector  
perfil

### Back Connecting Block

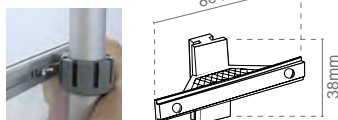
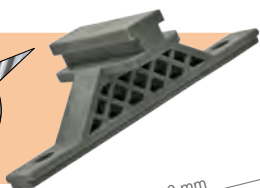

Back Con.

10.864

x10

conector  
perfil

### End Cap

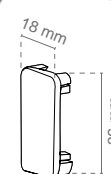
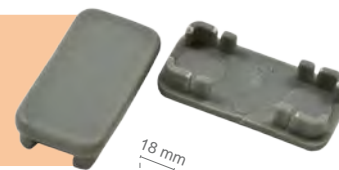

End Cap

10.971

x10

conectarlo  
al perfil

### Graphic Clip

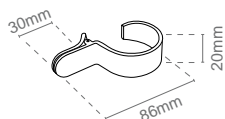

Graphic Clip

10.539 Ø 45mm x10

10.540 Ø 40mm x10

Clip Colgador  
de gráfica

### Wire Clip

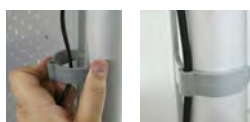

Wire Clip

10.541 Ø 45mm x10

10.542 Ø 40mm x10

sujeta  
cables

### Connecting Plate



19mm  
ancho

#### conector frontal



Con.Plata

100x19mm



10.972

x10

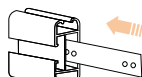

12mm ancho

#### conector lateral

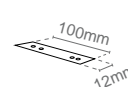

Con.Plata

100x12mm



10.973

x10

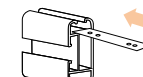

# Quick System

## Quick System

Plastic Clip



Plastic Clip

10.537

x10

Side Clip

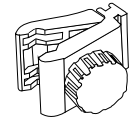

Side Clip

10.538

x10

Arc Shelf

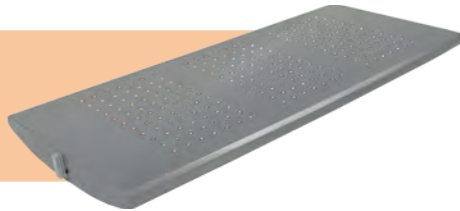

Arc Shelf

10.959

828x350mm

Shelf

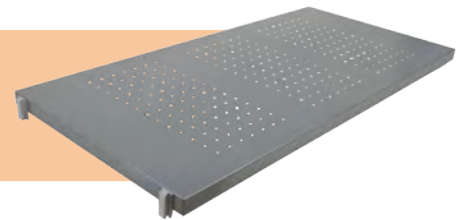

Shelf

10.960

825x400mm

LCD Bracket

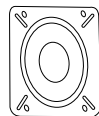
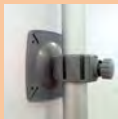

LCD Bracket

10.543

Panel

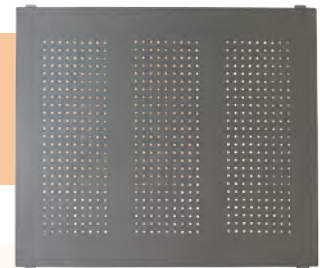

Panel

10.958

825x1000mm

Acrylic Brochure Holder



all brochures holders include Alu Block (ref. 10.969)



Brochure A4

10.544

A4

Brochure A5

10.545

A5

Brochure A6

10.546

A6

Arc Light Box

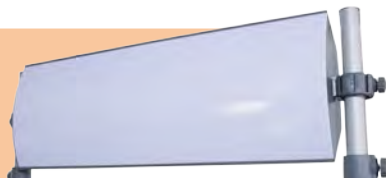

Arc Light Box

10.957

825x285mm

Spotlight



Spotlight

10.389

# Promotion Counters

Promotion Counters



**EN** Promotion counters for selling points. Quick and easy assembly. Fully removable. Carry Bag is included.  
**FR** Comptoir d'accueil pour point de vente. Rapide et facile à monter. Totalement démontable. Valise de transport incluse.

**PT** Balcão Promocional para ponto de venda. Fácil e rápido de montar. Totalmente desmontável. Inclui saco de transporte.  
**ES** Mostradores para promoción en punto de venta. Fácil y rápido montaje. Totalmente desmontables. Incluyen bolsa de transporte.

## Tavira

with 2 shelves, header and carry bag

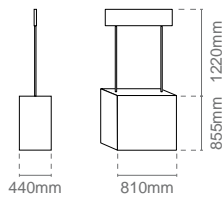

Tavira	QTY	N.W	G.W	C.B.M	Size
Packing	1	7.35kg	8.95kg	0.073	840x100x880mm

10.098 810x440x2075mm

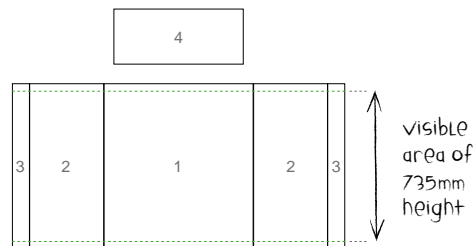

1: 820x805mm  
 2: 385x805mm  
 3: 115x805mm  
 4: 803x300mm

visible area of 735mm height

--- visible area  
 — graphic size

## Salmoral

## Belvis

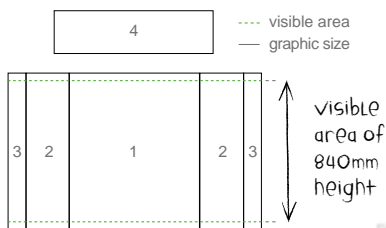

1: 870x910mm  
 2: 440x910mm  
 3: 100x910mm  
 4: 1000x255mm

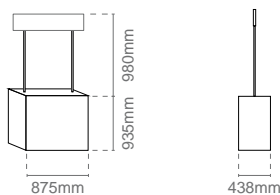

Salmoral	QTY	N.W	G.W	C.B.M	Size
Packing	1	6.8kg	8.25kg	0.051	560x70x1300mm

10.043 875x438x1915mm

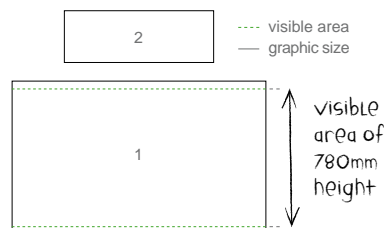

1: 1425x850mm  
 2: 770x280mm

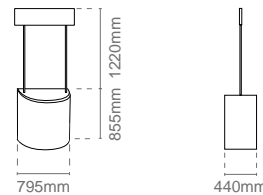

Belvis	QTY	N.W	G.W	C.B.M	Size
Packing	1	5.8kg	7.7kg	0.09	860x120x870mm

10.719 795x400x2075mm



# Promotion Counters

Promotion Counters



## Manchester

with  $\varnothing 500\text{mm}$   
circular shelf

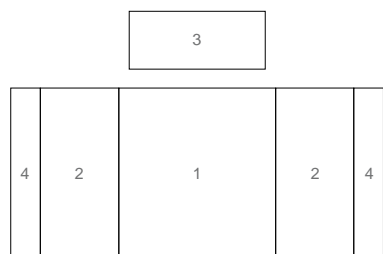

1: 824x850mm.  
2: 408x850mm.

3: 770x280mm.  
4: 115x850mm.

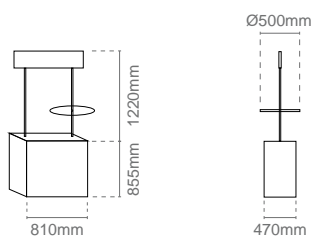

rápido y fácil  
de montar

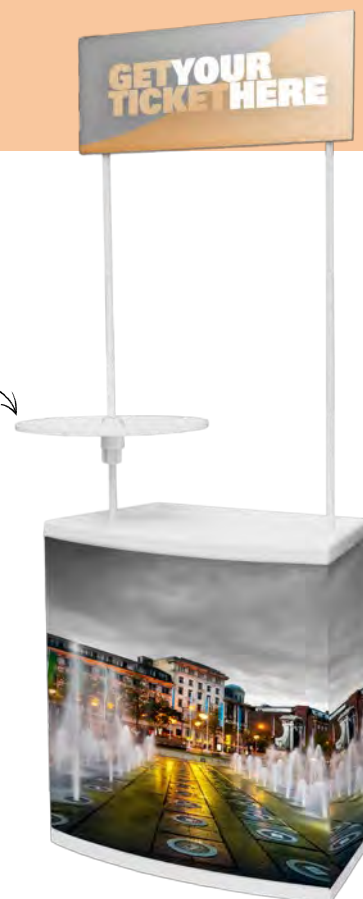

Manchester	QTY	N.W	G.W	C.B.M.	Size
Packing	1	9.5kg	10.5kg	0.08	860x110x880mm
10.676		810x470x2075mm			

## Lake

black coloured

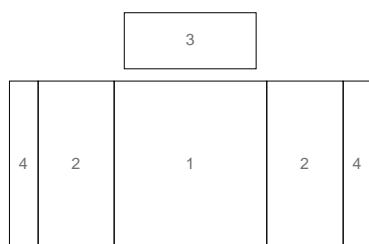

1: 824x850mm.  
2: 408x850mm.

3: 770x280mm.  
4: 115x850mm.

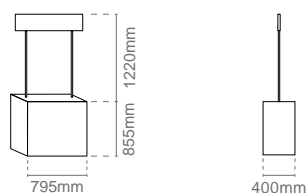

Ligero y  
portable



Lake	QTY	N.W	G.W	C.B.M.	Size
Packing	1	8.5kg	9.5kg	0.08	860x110x880mm
10.675		795x400x2075mm			

# Promotion Counters

Promotion Counters



## Sigüenza

incluye cerradura y balda

2	1	2
---	---	---

1: 1004x858mm.  
2: 322x858mm.

aluminio y madera

Sigüenza	QTY	N.W	G.W	C.B.M.	Size
Packing	1	27kg	30kg	0.23	950x200x1250mm
	10.493				



## Sepulveda

incluye cerradura y balda

4	3	4
2	1	2

1: 1004x858mm      3: 1122x227mm  
2: 322x858mm      4: 212x227mm

aluminio y madera

Sepulveda	QTY	N.W	G.W	C.B.M.	Size
Packing	1	36.8kg	41.9kg	0.18	940x160x1190mm
	10.494				





# Promotion Counters

Magnetic Counter | Velcro Counter  



## Cebreros

madera, aluminio  
y plástico

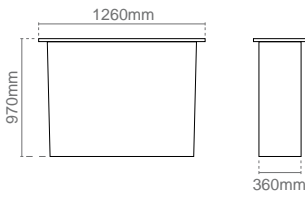
tapa superior  
amarilla o  
madera



Cebreros	QTY	N.W	G.W	C.B.M.	Size
Bottom	1	7.55kg	9.55kg	0.06	380x160x1030mm
Top	1	6.7kg	8.35kg	0.04	460x110x750mm

NEW 10.392    
10.042  Graphic Size: 2035x945mm



pop up magnético



## Villares

pop up velcro



con estante  
de plástico

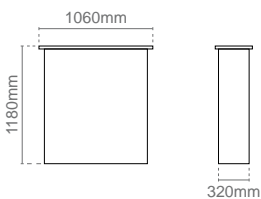

Villares	QTY	N.W	G.W	C.B.M.	Size
Bottom	1	3.1kg	6.85kg	0.12	445x230x1130mm
Top	1	5.45kg	6.6kg	0.04	465x70x1120mm

10.096  Graphic Size: 1770x1000mm



ligero y  
portable

# Promotion Counters

Velcro Counter   

Ajalvir

**NEW**

lighero y portable

madera  
color negro



**ECONOMIC**



economic velcro pop up counter with 2 wooden shelves

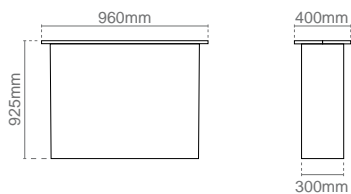
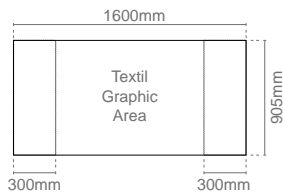

bolsa transporte incluida

con tapa superior



Ajalvir	QTY	N.W	G.W	C.B.M.	Size
Packing	1	8.55kg	9.55kg	0.11	400x250x1130mm
10.323		Graphic Size: 900x1595mm			

# Promotion Counters

Promotion Counters  

## Cezures

madera  
color negro

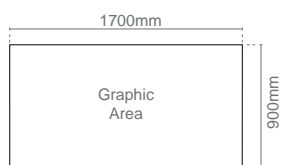
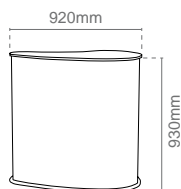

rápido y  
fácil montaje

Cezures	QTY	N.W	G.W	C.B.M.	Size
Packing	2	7.7kg	15kg	0.02	570x380x940mm
10.686	Graphic Size: 1700x900mm				

## Atenas

with upper  
header

**NEW**

bolsa de transporte incluida

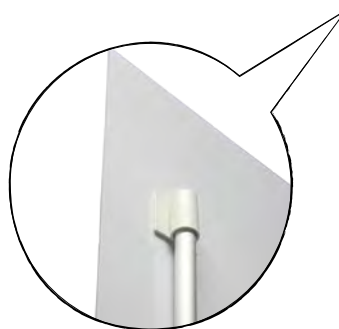
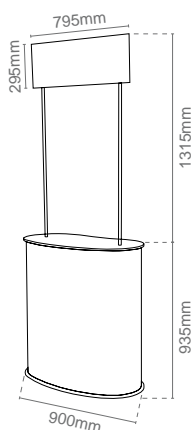

Atenas	QTY	N.W	G.W	C.B.M.	Size
Packing	1	25.8kg	27kg	0.21	500x440x940mm
10.312	Graphic Size: 1800x900mm				

# Promotion Counters

Promotion Counters  

## Doiras

disponible en negro y color madera

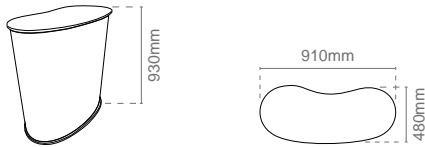
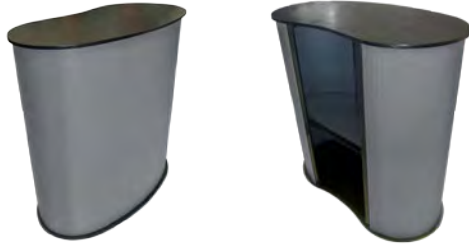

bolsa de transporte incluida

Doiras	QTY	N.W	G.W	C.B.M.	Size
Packing	2	12kg 1.5kg	13kg 2kg	0.0372 0.0372	500x80x930mm 200x200x930mm
13.475		Graphic Size: 1850x900mm			
13.476					

## Valdes

rápido y fácil de montar y guardar

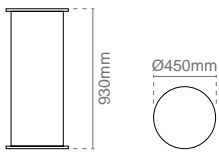

Valdes	QTY	N.W	G.W	C.B.M.	Size
Packing	2	3.8kg 2.7kg	4.3kg 3.2kg	0.016 0.037	460x80x460mm 200x200x930mm
10.685	Graphic Size: 1225x900mm				

## Libourne

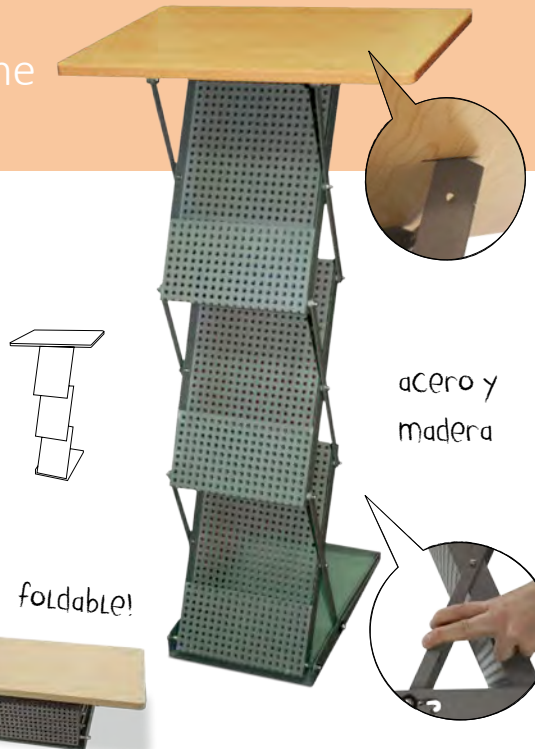
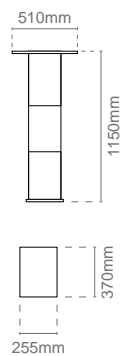

acero y madera

foldable!

Libourne	QTY	N.W	G.W	C.B.M.	Size
Packing	1	7.35kg	7.8kg	0.03	400x160x540mm
10.417	510x370x980mm				

# Promotion Counters

## Tension Fabric Counters



EN Aluminium Tension fabric counter with top and wooden base.  
FR Comptoir pour toile tendue. Fabriqué en aluminium et bois.

PT Balcão de alumínio para colocação de tela mediante tensão.  
ES Mostrador Tension Fabric, estructura de aluminio, base y encimera de madera.

Creta

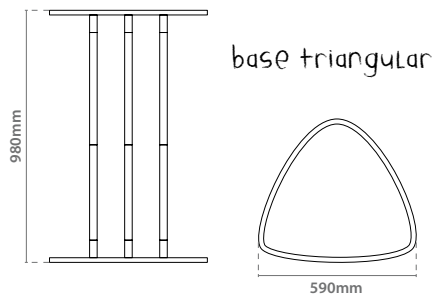

3 puntos de tensado

Creta	QTY	N.W	G.W	C.B.M.	Size
Packing	1	6.85kg	7.5kg	0.04	640x130x440mm
10.311	Graphic Size: 1790x1100mm				



\*Printed on fabric.  
Impression sur toile.  
Impressão em tecido.  
Impresión en tela.



Siena



fabric fixed by silicone strip



sistema guía hidráulico

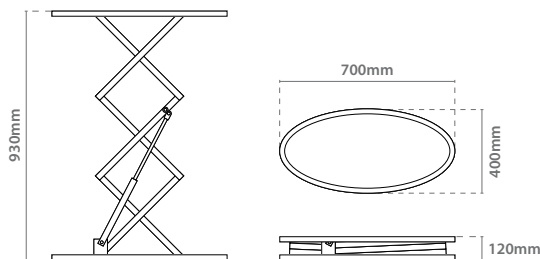

rápido plegado



Siena	QTY	N.W	G.W	C.B.M.	Size
Packing	1	5.6kg	7.6kg	0.21	970x600x360mm
15.244	Graphic Size: 940x1739mm				



\*Printed on fabric.  
Impression sur toile.  
Impressão em tecido.  
Impresión en tela.



# Promotion Counters

Tension Fabric Counters



## Manacor

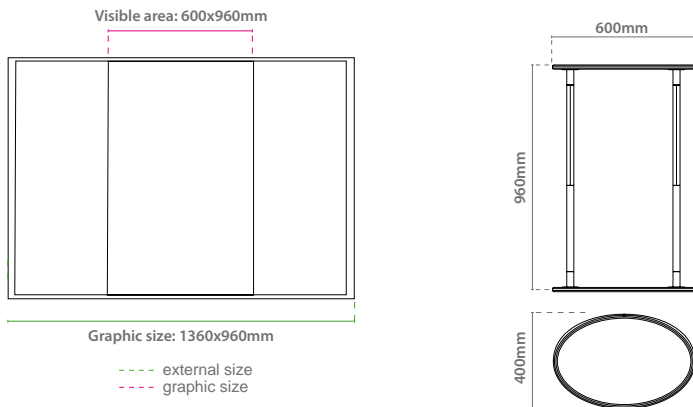

Manacor	QTY	N.W	G.W	C.B.M.	Size
Packing	1	7.0kg	7.44kg	0.0366	440x130x640mm
10.318		Graphic Size: 1360x960mm			



\*Printing on fabric.  
Impression sur toile.  
Impressão em tecido.  
Impresión en tela.

## Mahon

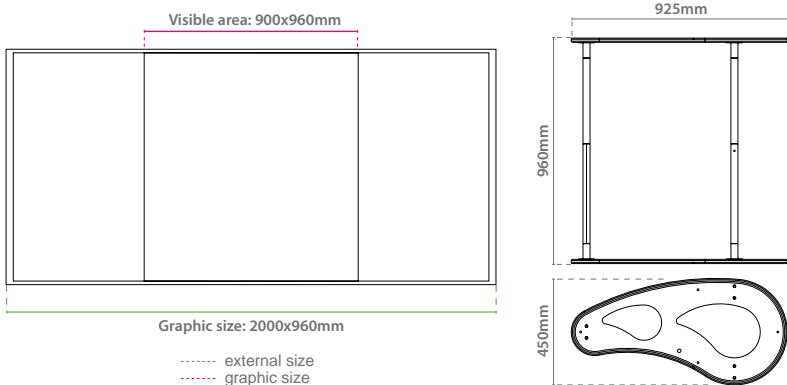

Mahon	QTY	N.W	G.W	C.B.M.	Size
Packing	1	10.50kg	10.93kg	0.0672	500x140x960mm
10.319		Graphic Size: 2000x960mm			



\*Printing on fabric.  
Impression sur toile.  
Impressão em tecido.  
Impresión en tela.

# Carton Display

Cardboard Counters



**EN** Cardboard promotion counter. Both sides are white coated. Thickness 1.5mm. Printing is not included.

**FR** Comptoir en carton de couleur blanche, double face et 1,5mm d'épaisseur. Prix sans impression.

**PT** Balcão promocional em cartão branco. Espessura do cartão: 1.5 mm. Impressão não incluída.

**ES** Mostrador fabricado en cartón blanco estucado, dos caras, e=1.5mm. El precio no incluye la impresión.

## Praga Cardboard Display Counter

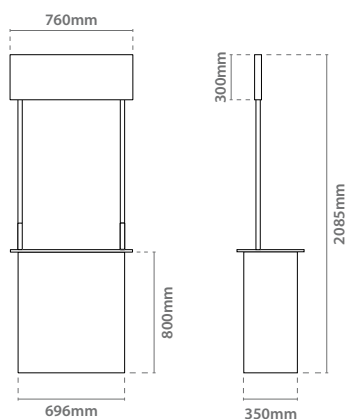

Praga	QTY	N.W	G.W	C.B.M.	Size
Packing	1	3.05kg	3.9kg	0.0443	920x45x1070mm
10.730		696x350x2085mm			

pvc bars



## Londres Cardboard Promotion Counter

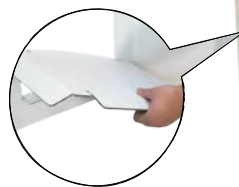
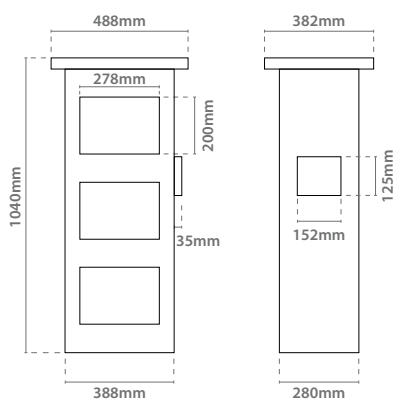

estantes de Cartón  
grosor: 5mm



Londres	QTY	N.W	G.W	C.B.M.	Size
Packing	1	1.35kg	2kg	0.0266	425x60x1045mm
10.733		488x382x1040mm			

# Carton Display

Cardboard Dumpbin   

**EN** Cardboard dumpbin. Cardboard's thickness: 3mm, two white coated sides. Printing is not included.

**FR** Comptoir fabriqué en carton blanc double face de 3mm d'épaisseur. Prix sans impression.

**PT** Balcão promocional fabricado em cartão de cor branca. Espessura do cartão 3mm. Impressão não incluída.

**ES** Cesta fabricada en cartón blanco de dos caras y e=3mm. El precio no incluye la impresión.

## Accra Cardboard Dumpbin

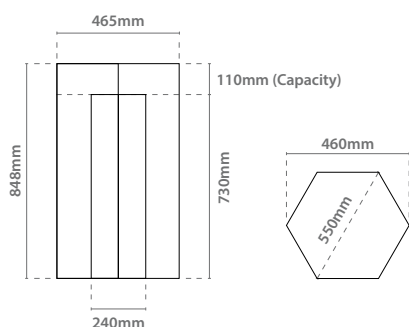

rápido y fácil  
montaje



Accra	QTY	N.W	G.W	C.B.M.	Size
Packing	1	1.35kg	2kg	0.018	830x25x910mm
13.466					

## Lagos Cardboard Dumpbin

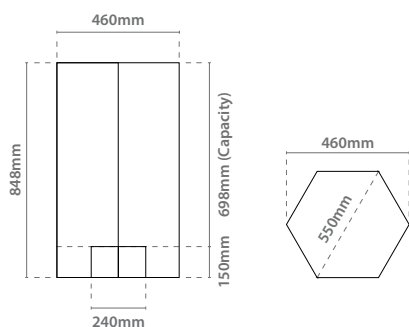

cartón estucado  
blanco

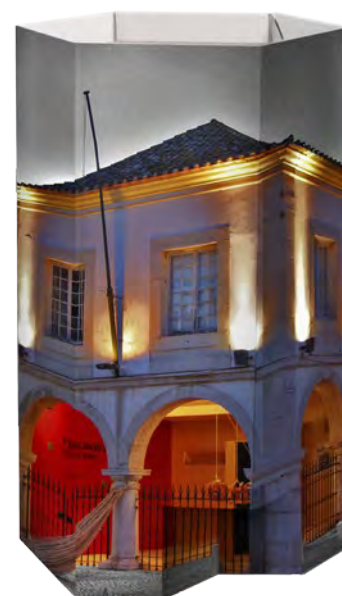

Lagos	QTY	N.W	G.W	C.B.M.	Size
Packing	1	1.35kg	2kg	0.018	830x25x910mm
13.467					



# Carton Display

Cardboard Dumpbin / Cardboard Display



## Berna Cardboard Dumpbin

easy and fast  
set up !

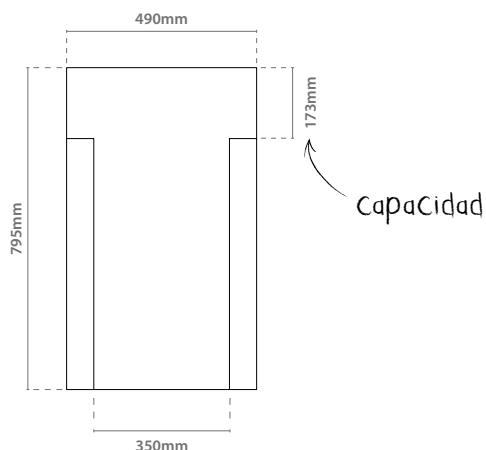

impresión  
no incluida



Berna	QTY	N.W	G.W	C.B.M.	Size
Packing	1	1.15kg	1.8kg	0.0255	850x30x1000mm
10.732		490x490x795mm			

## Oslo 6 Cases Cardboard Display

EN Cardboard display with two white coated sides. Poster: 5mm cardboard's thickness. Tray: 1.5mm cardboard's thickness. Base: 5mm Cardboard's thickness. Printing is not included.

FR Présentoir fabriqué en carton blanc double face. Poster: carton blanc de 5mm d'épaisseur. Étagère: carton de 1,5mm d'épaisseur. Base: carton de 5mm d'épaisseur. Prix sans impression.

PT Balcão promocional em cartão branco de ambos os lados. Poster: Espessura do cartão 5mm. Prateleira: Espessura do cartão 1,5mm. Base: Espessura do cartão 5mm. Impressão não incluída.

ES Display fabricado en cartón blanco estucado dos caras. Cartela fabricada en canal medio, e=5mm. Cubeta fabricada en microcanal, e=1.5mm. Base en canal medio de e=5mm. Precio sin impresión.

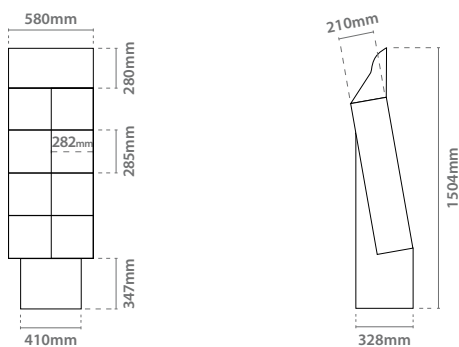

con seis  
huecos

Oslo	QTY	N.W	G.W	C.B.M.	Size
Packing	1	2.8kg	3.9kg	0.2196	820x255x1050mm
10.731		580x328x1500mm			

# Carton Display

Cardboard Display   

## Viena Cardboard Floor Display

- EN Cardboard promotion counter in white colour. Cardboard's thickness: 3mm, with two white coated sides. Printing is not included.
- FR Présentoir promotionnel fabriqué en carton blanc, avec double face de 3mm d'épaisseur. Prix sans impression.
- PT Balcão promocional fabricado em cartão. Cor branca de ambos os lados. Cartão com espessura de 3mm. Impressão não incluída.
- ES Display promocional fabricado en cartón blanco estucado de dos caras con e=3mm. El precio no incluye la impresión.

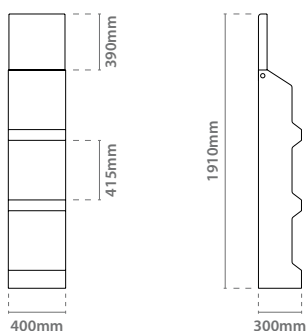

con 3 huecos



Viena	QTY	N.W	G.W	C.B.M.	Size
Packing	1	1.1kg	1.7kg	0.0222	720x20x1540mm
10.734		400x300x1910mm			

## Budapest Cardboard Hook Display

disponibles diferentes modelos de ganchos

- EN Cardboard hook display. Cardboard's thickness: 1.5mm, 2 white coated sides. Printing and hooks are not included. Easy assembly.
- FR Présentoir promotionnel en carton blanc de double face, de 1,5mm d'épaisseur. Impression et accroches non inclus.
- PT Display para ganchos em cartão. Cor branca. Cartão com espessura de 1,5mm, branco de ambos lados. Preços não incluem mica adesiva. Preços não incluem ganchos. Configuração faça você mesmo.
- ES Display fabricado en cartón blanco estucado de 2 caras y e=1.5mm. La impresión y los ganchos no están incluidos. De fácil montaje.

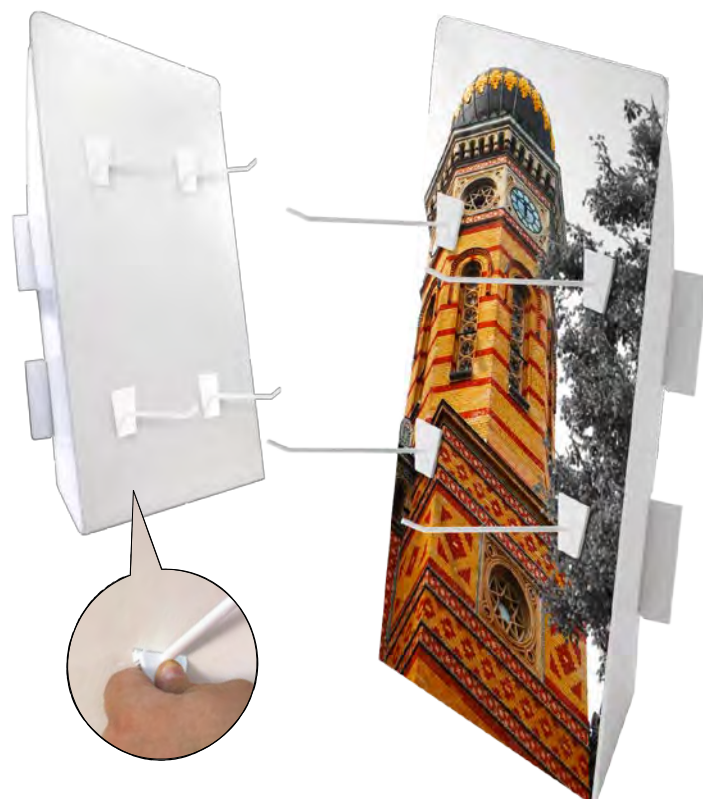
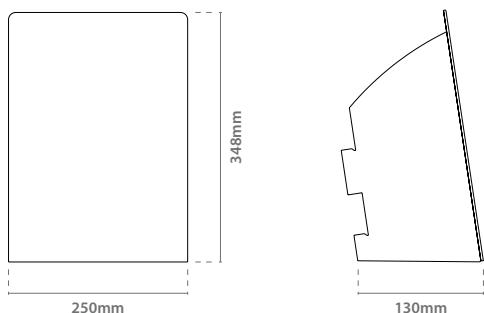

Budapest	QTY	N.W	G.W	C.B.M.	Size
Packing	5	0.105kg	0.525kg	0.0038	260x35x415mm
10.831		250x350mm		x5	

# Carton Display

Cardboard Ballot Box | Cardboard Display | Cardboard Stand



## Trieste Cardboard Ballot Box

**NEW**

fácil y rápido  
montaje

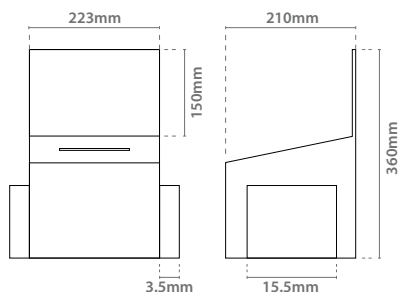

Trieste	QTY	N.W	G.W	C.B.M.	Size
Packing	5	1.25kg	1.55kg	0.01	430x50x490mm
13.080	223x210x360mm		x5		



2 mm  
grosor



## Burdeos Top Display Cardboard Counter

impresión  
no incluida

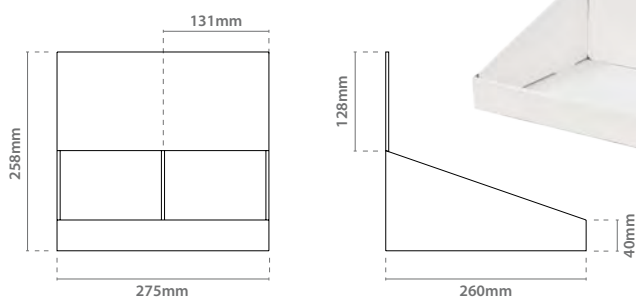

Burdeos	QTY	N.W	G.W	C.B.M.	Size
Packing	5	1.1kg	1.44kg	0.0123	490x45x560mm
10.868	275x260x258mm		x5		



1.5 mm  
grosor



## Belgrado Cardboard Brochure Stand

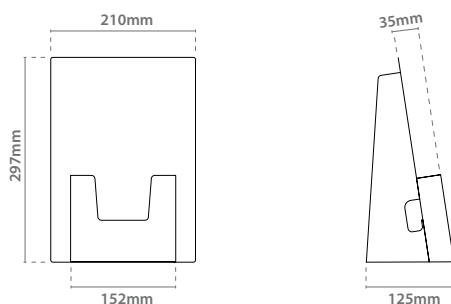
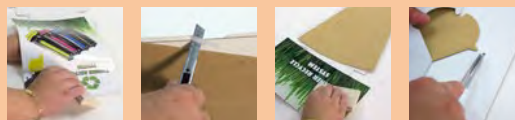

Belgrado	QTY	N.W	G.W	C.B.M.	Size
Packing	5	0.33kg	0.5kg	0.0034	275x40x310mm
10.881	210x125x297mm		x5		

1.5 mm  
grosor



# Carton Display Accessories

Showcard | Caster 

## Adhesive Showcard

transparent colour

- EN Transparent showcard with adhesive on top and bottom back part for a better attachment.
- FR Porte affiches comprenant un adhésif à l'arrière sur la partie haute et basse permettant une meilleure fixation.
- PT Mica transparente em PVC com adesivo superior e inferior na parte posterior para uma maior fixação.
- ES Filmína de PVC con adhesivo superior e inferior en la parte posterior para una mayor sujeción.

7 tamaños disponibles

Showcard				
13.428	A1	0.5mm	x10	
13.429	A2	0.5mm	x10	
13.064	A3	0.5mm	x10	
13.065	A4	0.5mm	x10	
13.066	A5	0.5mm	x20	
13.067	A6	0.5mm	x20	
13.430	A7	0.5mm	x30	

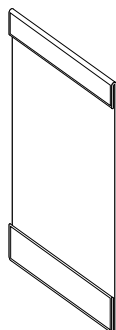

con adhesivo

## Plastic Display Caster

reinforce your display



- EN The plastic feet reinforce the cardboard displays. Raise the cardboard display to avoid the contact with the ground.
- FR Pieds en plastique pour le renfort de display en carton. Eève le display de carton pour éviter le contact avec le sol.

- PT Pé de plástico para reforçar os displays de cartão. Eleva os displays de cartão para evitar o contacto com o chão.
- ES Patas de plástico para el refuerzo de los displays de cartón. Elevan el display de cartón para evitar el contacto con el suelo.

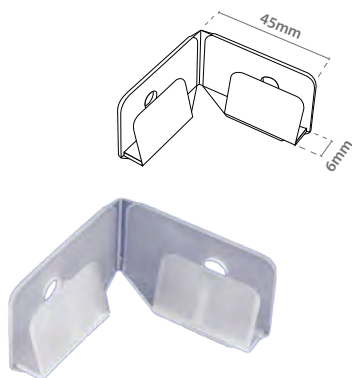

D. Caster  
12.286 Simple x50 

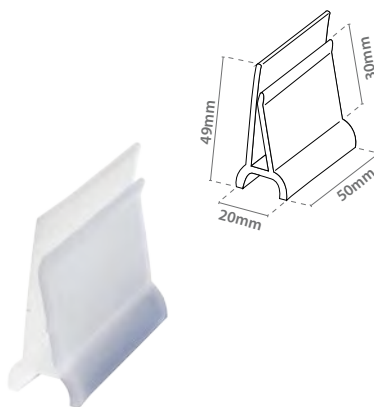

D. Caster  
12.518 Clip x100 

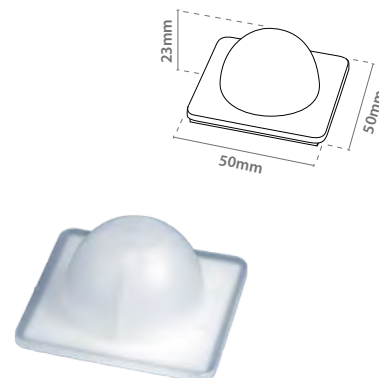

D. Caster  
12.287 Adhesive x50 

# Carton Display Accessories

## Cardboard Hooks | Prongs

EN Heavy-duty plastic hooks and prongs for cardboard displays.

FR Divers types de broches pour fixer directement au carton.

PT Diferentes tipos de gancho em plástico para expositores em cartão.

ES Diferentes tipos de ganchos de plástico para colocar sobre carton.

### Simple or Double Quick-Stick Prong

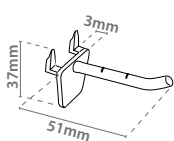
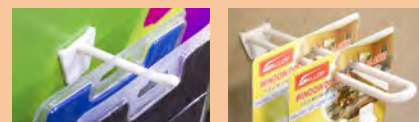
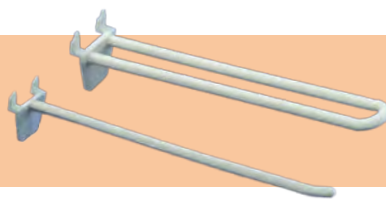

S. Prong

12.261 51mm x50 

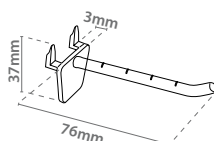

S. Prong

12.262 76mm x50 

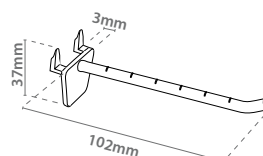

S. Prong

12.263 102mm x50 

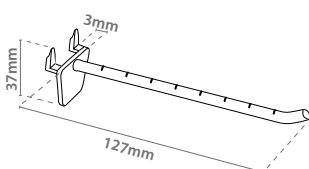

S. Prong

12.264 127mm x50 

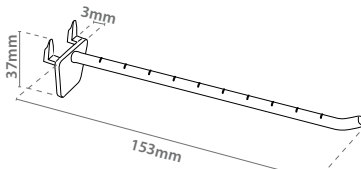

S. Prong

12.265 153mm x50 

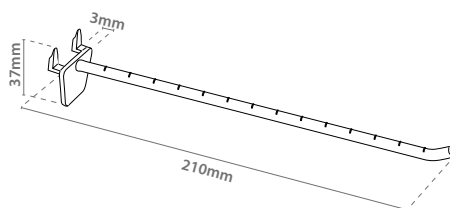

S. Prong

12.266 210mm x50 

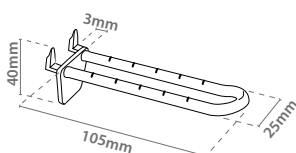

D. Prong

12.258 105mm x50 

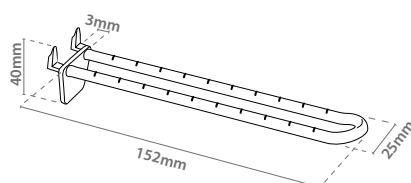

D. Prong

12.259 152mm x50 

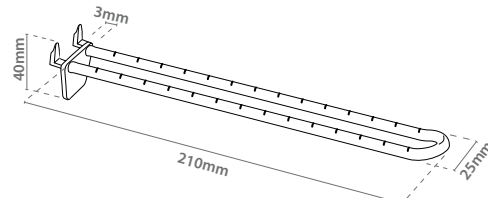

D. Prong

12.260 210mm x50 

### Insert Flat Prong

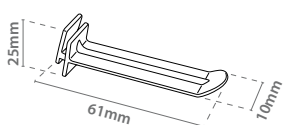

Insert Prong

12.269 61mm x50 

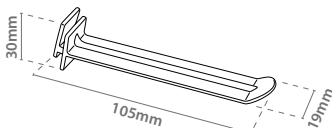

Insert Prong

12.270 105mm x50 

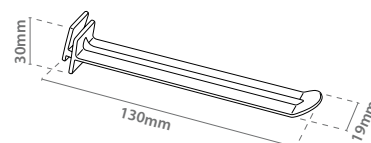

Insert Prong

12.271 130mm x50 

# Carton Display Accessories

## Cardboard Prongs

### Insert Prong

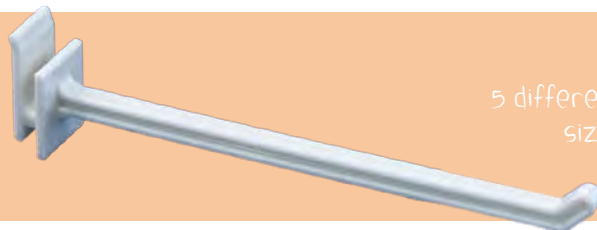

5 different sizes



para insertar en el cartón

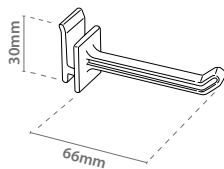

Insert Prong  
12.272 66mm x50 

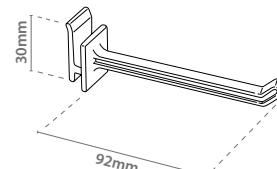

Insert Prong  
12.273 92mm x50 

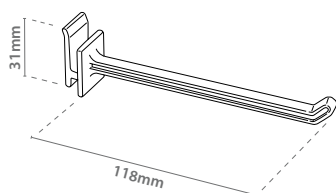

Insert Prong  
12.274 118mm x50 

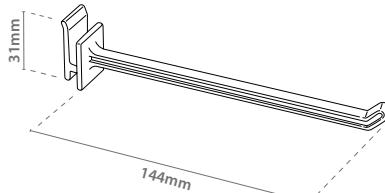

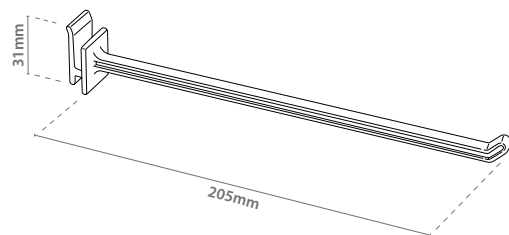

Insert Prong  
12.275 144mm x50 

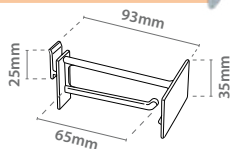
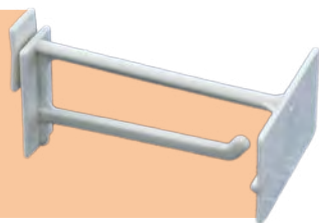

Insert Prong  
12.276 205mm x50 

### Insert Prong with Holder



Price Prong  
12.112 65mm x50 

con porta precio

### Slat Wall Prong

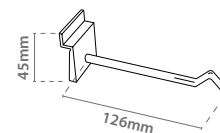
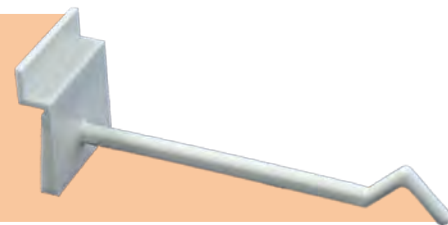

S.Wall Prong  
12.111 126mm x50 

para insertar en Carril

### Clip Prong

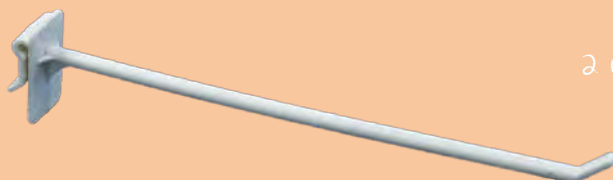

2 different sizes

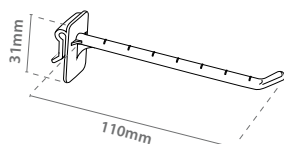

Clip Prong  
12.267 110mm x50 

2 tamaños disponibles

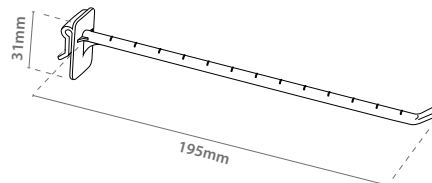

Clip Prong  
12.268 195mm x50 

# Carton Display Accessories

Cardboard Holders | Bracket Clip 

## Cardboard Holders

3 tamaños diferentes

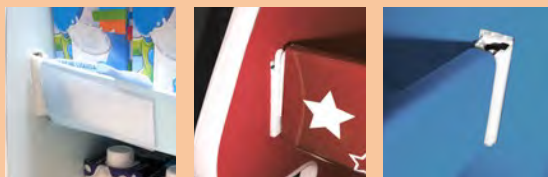

EN Interlocking pieces for the support of shelves in cardboard.  
FR Pièces de plastique pour support d'étagères en carton.

PT Peças que se interligam para sustentar prateleiras de cartão.  
ES Piezas ensamblables para el soporte de baldas de cartón.

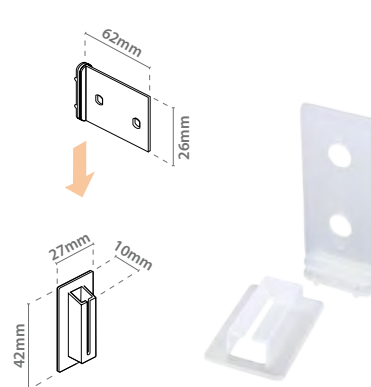
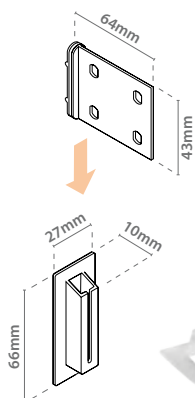
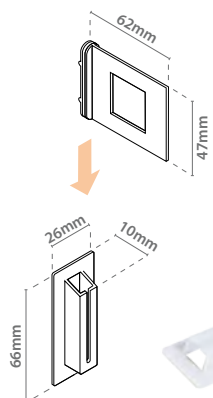

C. Holders  
12.515 x50 

C. Holders  
12.516 x50 

C. Holders  
12.517 x50 

## Corrugated Bracket Clip



EN Transparent PVC clip designed for holding graphics and shelves.  
FR Support en pvc transparent pour fixation d'images et d'étagères.

PT Suporte de PVC para a fixação de imagens e prateleiras.  
ES Clip transparente de PVC para soporte de gráficas y baldas.

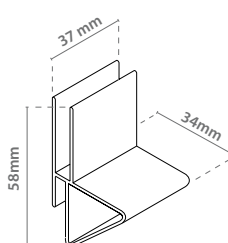
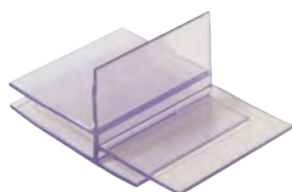
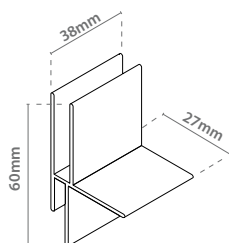

transparente

Bracket Clip  
12.514 x50 

Bracket Clip  
12.513 x50 

# Carton Display Accessories

## Rivets | Screws

EN Screws and rivets made of plastic for the signage attachment.

FR Vis et écrou en plastique pour la fixation de l'affichage.

PT Porca e parafuso em plástico para a fixação de impressões.

ES Tornillos y tuercas realizados en plástico para fijación de cartelería.



12.283



12.283 Ø15 | Ø5mm 5.5mm x100 📦

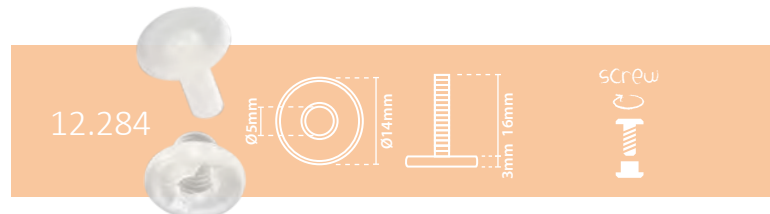

12.284



12.284 Ø14 | Ø5mm 16mm x100 📦

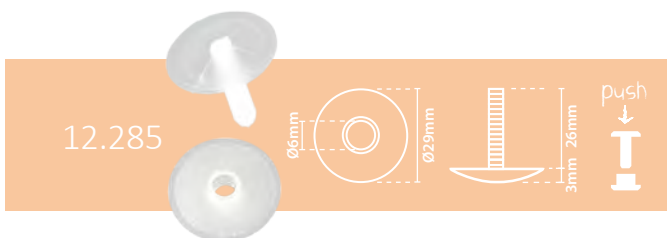

12.285



12.285 Ø29 | Ø6mm 26mm x100 📦

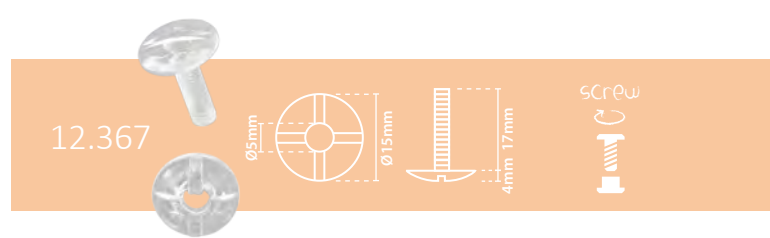

12.367



12.367 Ø15 | Ø5mm 17mm x100 📦



12.114



12.114 Ø30 | Ø6mm 12mm x100 📦

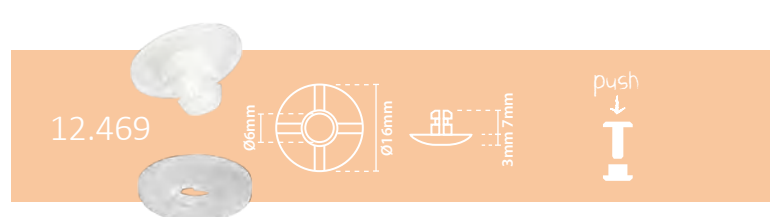

12.469



12.469 Ø16 | Ø8mm 7mm x100 📦



# Carton Display Accessories

## Rivets | Screws | Plastic Hooks

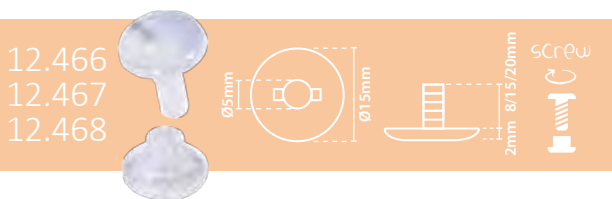

12.466	Ø15   Ø5mm	8mm	x100
12.467	Ø15   Ø5mm	15mm	x100
12.468	Ø15   Ø5mm	20mm	x100

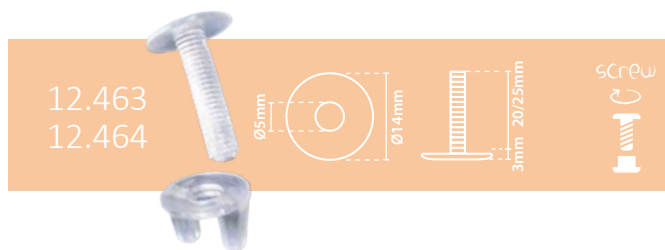

12.463	Ø14   Ø5mm	20mm	x100
12.464	Ø14   Ø5mm	25mm	x100



**NEW**

12.521	Ø6   Ø5.8mm	10mm	x100
--------	-------------	------	------

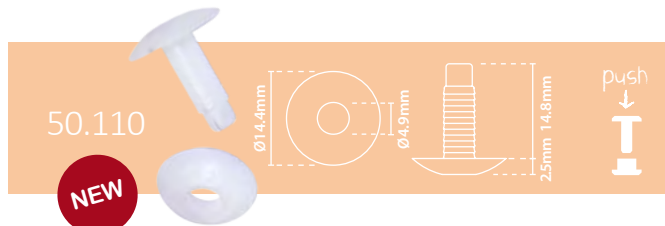

**NEW**

50.110	Ø14.4   Ø4.9mm	14.8mm	x100
--------	----------------	--------	------



**NEW**

50.111	Ø6.2   Ø4.6mm	9.5mm	x100
--------	---------------	-------	------

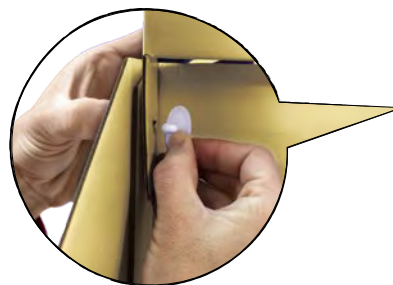

tuercas,  
y otros elementos  
de fijación realizados  
en plástico

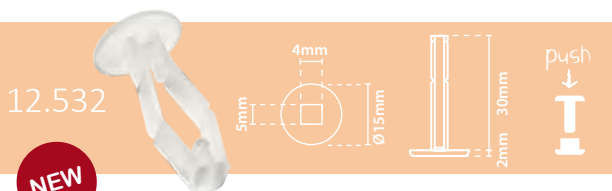

**NEW**

12.532	Ø15   6x5mm	30/12mm	x100
--------	-------------	---------	------

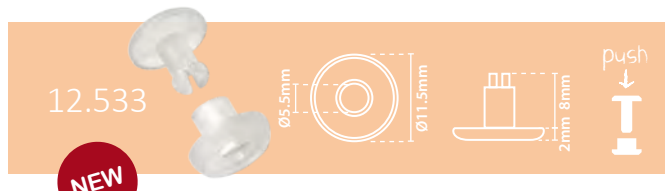

**NEW**

12.533	Ø11.5   Ø5.5mm	10mm	x100
--------	----------------	------	------

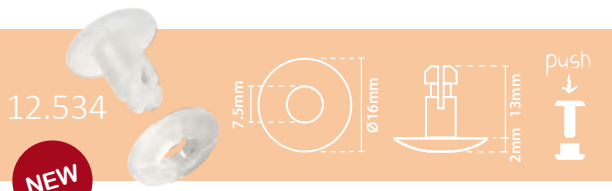

**NEW**

12.534	Ø16   Ø7.5mm	15.5mm	x100
--------	--------------	--------	------

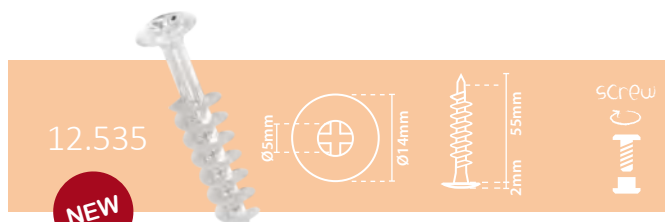

**NEW**

12.535	Ø14mm	56mm	x100
--------	-------	------	------

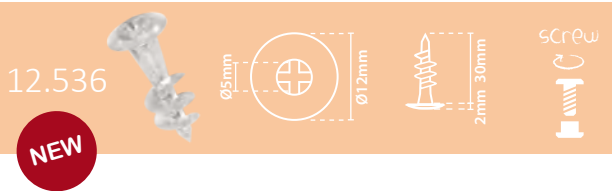

**NEW**

12.536	Ø14mm	32mm	x100
--------	-------	------	------

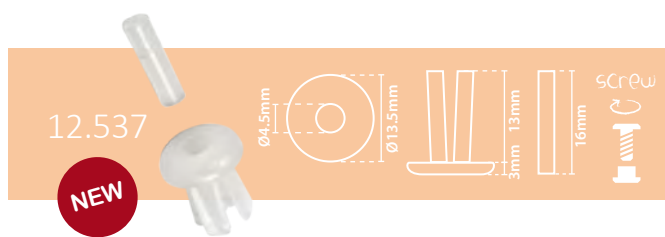

**NEW**

12.537	Ø13.5   Ø4.5mm	16mm	x100
--------	----------------	------	------

# Carton Display Accessories

Cardboard Easel  

Cardboard Easel



7 tamaños diferentes

EN Cardboard easel. Colour: White.  
 FR Chevalet en carton blanc.  
 PT Cavalete em cartão de cor branca.  
 ES Peanas para cartón. Color Blanco.



7 sizes available

Card.Easel	QTY	N.W	G.W	C.B.M.	Size
Packing	50	0.37kg	0.45kg	0.0029	170x85x200mm
12.085	140mm	x50			



Card.Easel	QTY	N.W	G.W	C.B.M.	Size
Packing	50	0.91kg	1.05kg	0.0073	250x85x340mm
12.086	275mm	x50			



Card.Easel	QTY	N.W	G.W	C.B.M.	Size
Packing	50	0.56kg	0.71kg	0.0056	240x65x365mm
12.115	310mm	x50			



Card.Easel	QTY	N.W	G.W	C.B.M.	Size
Packing	50	2kg	2.7kg	0.0074	395x310x605mm
12.444	470mm	x50			

Card.Easel	QTY	N.W	G.W	C.B.M.	Size
Packing	20	1.97kg	2.4kg	0.0171	565x40x760mm
12.116	680mm	x20			

Card.Easel	QTY	N.W	G.W	C.B.M.	Size
Packing	20	8kg	9.2kg	0.117	565x290x720mm
12.445	900mm	x20			

Card.Easel	QTY	N.W	G.W	C.B.M.	Size
Packing	20	10kg	11.4kg	0.15	720x290x720mm
12.446	1380mm	x20			



# Carton Display Accessories

Cardboard Easel  

Sheets

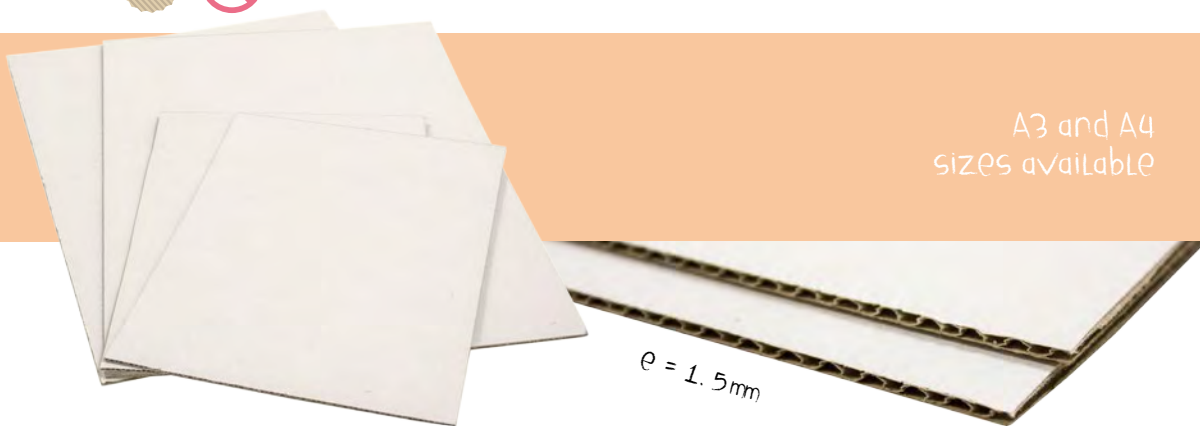

A3 and A4 sizes available

10.994	A4	x10 
10.995	A3	x10 

Cartón blanco dos caras

PVC hanger



Fixing Spears

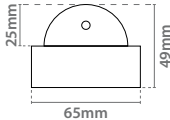
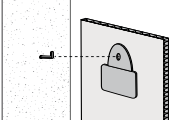

EN	Thickness: 0,04mm.		
FR	Epaisseur: 0,04mm.		
PT	Espessura: 0,04mm.		
ES	Espesor: 0,04mm.		



12.512	65x49mm	 50 Uni.
--------	---------	---

12.538	Length: 37mm	x100 
--------	--------------	--

Plastic Hooks



hook it on cardboard

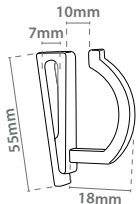

EN	White plastic hooks designed for placing it on cardboard. Two sizes available.	
FR	Crochet de plastique pour expositeurs de carton. En deux dimensions.	

PT	Gancho de plástico para expositores de cartão. Disponível em dois tamanhos.	
ES	Ganchos de plástico. Pueden acoplarse a distintos sistemas o directamente a la cartelería.	

12.074	24x29mm	x50 
--------	---------	---

12.279	55x37mm	x50 t
--------	---------	-------

Magic Tape



EN	Adhesive Velcro coins. Male or female.
FR	Rouleau de boutons, en velcro adhésif, mâle ou femelle.

PT	Botões de velcro adesivo. Macho ou fêmea.
ES	Botones adhesivos blancos de velcro. Macho o hembra.

Magic Tape	12.505 ♂10mm
	12.506 ♀10mm x1000 

Magic Tape	12.507 ♂20mm
	12.508 ♀20mm x1000 

Magic Tape	12.509 ♂25mm
	12.510 ♀25mm x1000 

# Poster System

Poster System  

**EN** Poster System for graphical support through suspension. The changes of graphics can be done in a quick and easy way. Each kit contains all the needed elements for assembly: profile bar and hangers. Different colours available.

**FR** Barre à clips pour suspension de visuel. Permet le changement rapide et simple des visuels. Kit complet (profil et anneaux). Disponible en plusieurs couleurs.

**PT** Perfil para a suspensão de imagens. Mudança de imagem rápida e fácil. Cada kit inclui todos os elementos necessários à sua montagem: perfil e ganchos de suspensão.

**ES** Kit sistema Cheapclip para soporte de gráfica mediante suspensión. Preparado para realizar los cambios de gráfica de manera rápida y sencilla. Contiene todos los elementos necesarios para su montaje (perfiles y colgadores). Disponible en varios colores.

## CheapClip

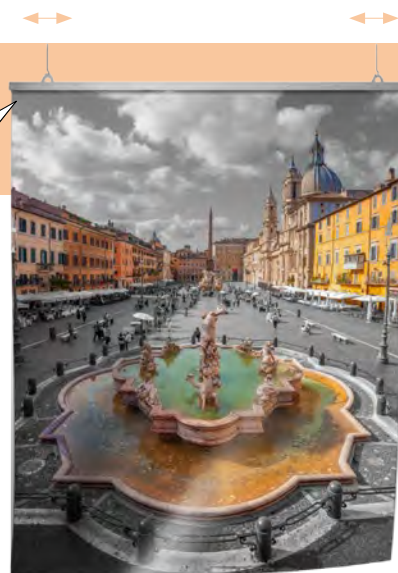
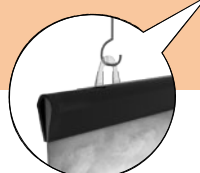
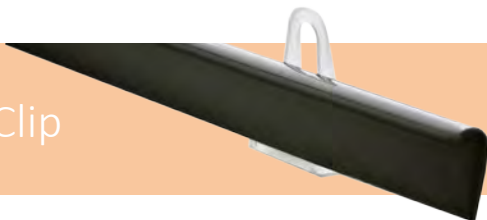

Cheap Clip	QTY	N.W	G.W	C.B.M.	Size
Packing	12	0.16kg	0.36kg	0.014	360x80x520mm

10.621		500mm	x12	
10.622				
10.623				

Cheap Clip	QTY	N.W	G.W	C.B.M.	Size
Packing	12	0.28kg	0.48kg	0.023	360x80x820mm

10.624		800mm	x12	
10.625				
10.626				

Cheap Clip	QTY	N.W	G.W	C.B.M.	Size
Packing	12	0.36kg	0.56kg	0.029	360x80x1020mm

10.627		1000mm	x12	
10.628				
10.629				

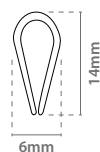

3 tamaños,  
3 colores  
disponibles

transparente  
blanco  
negro

## SoftClip

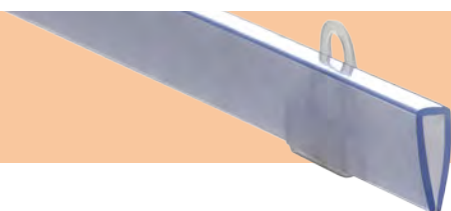

Soft Clip	QTY	N.W	G.W	C.B.M.	Size
Packing	12	0.28kg	0.4kg	0.014	360x80x520mm

10.612		500mm	x12	
10.613				
10.614				

Soft Clip	QTY	N.W	G.W	C.B.M.	Size
Packing	12	0.52kg	0.72kg	0.023	360x80x820mm

10.615		800mm	x12	
10.616				
10.617				

Soft Clip	QTY	N.W	G.W	C.B.M.	Size
Packing	12	0.72kg	0.91kg	0.029	360x80x1020mm

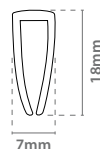

10.618		1000mm	x12	
10.619				
10.620				



3 tamaños,  
3 colores  
disponibles





transparente  
blanco  
negro

# Poster System

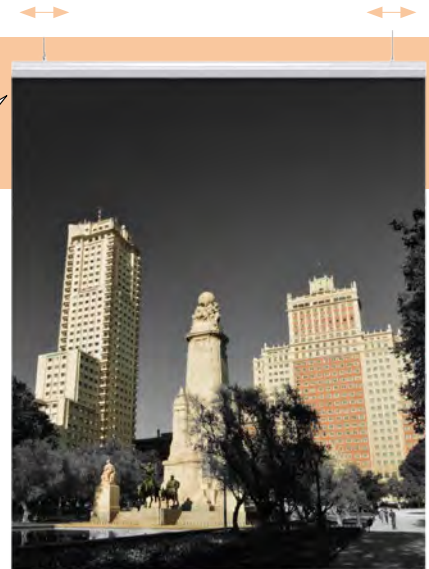
Poster System  

## BestClip



Best Clip	QTY	N.W	G.W	C.B.M.	Size
Packing	12	0.4kg	0.6kg	0.014	360x80x520mm
10.603					
10.604			500mm		x12 
10.605					
Best Clip	QTY	N.W	G.W	C.B.M.	Size
Packing	12	0.64kg	0.84kg	0.023	360x80x820mm
10.606					
10.607			800mm		x12 
10.608					
Best Clip	QTY	N.W	G.W	C.B.M.	Size
Packing	12	0.72kg	0.92kg	0.029	360x80x1020mm
10.609					
10.610			1000mm		x12 
10.611					

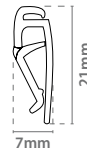

3 tamaños,  
3 colores  
disponibles

transparente  
blanco  
negro



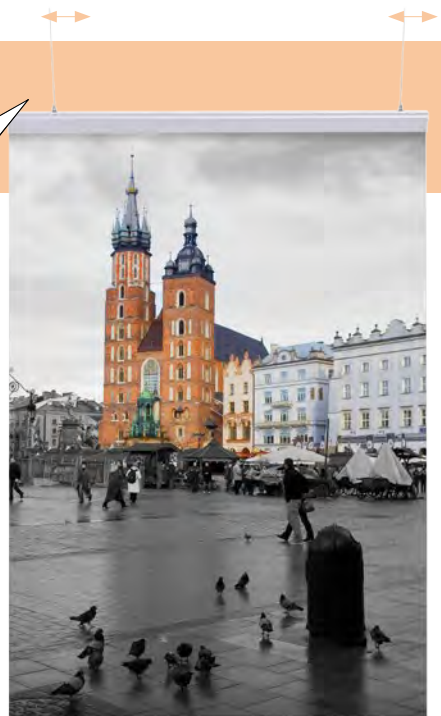





## PlastiClip



5 tamaños  
disponibles

blanco o negro



Plasti Clip	QTY	N.W	G.W	C.B.M.	Size
Packing	12	0.48kg	0.68kg	0.004	130x90x440mm
10.526					
10.527			440mm		x12 
Plasti Clip	QTY	N.W	G.W	C.B.M.	Size
Packing	12	0.6kg	0.8kg	0.005	130x90x500mm
10.528					
10.529			500mm		x12 
Plasti Clip	QTY	N.W	G.W	C.B.M.	Size
Packing	12	0.72kg	0.92kg	0.007	360x90x600mm
10.530					
10.531			600mm		x12 









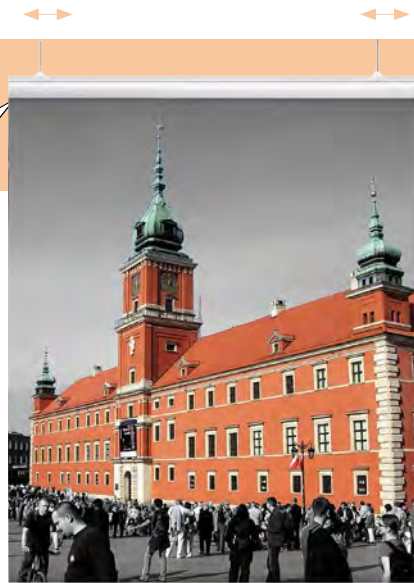
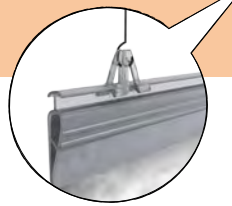

Plasti Clip	QTY	N.W	G.W	C.B.M.	Size
Packing	12	0.88kg	1.05kg	0.009	130x90x800mm
10.532					
10.533			800mm		x12 
Plasti Clip	QTY	N.W	G.W	C.B.M.	Size
Packing	12	1.08kg	1.2kg	0.01	130x90x1000mm
10.534					
10.535			1000mm		x12 

# Poster System

Poster System  

## StrongClip



Strong Clip	QTY	N.W	G.W	C.B.M.	Size
Packing	12	0.52kg	0.72kg	0.029	360x160x520mm
10.630					
10.631			500mm		x12 
10.632					
Strong Clip	QTY	N.W	G.W	C.B.M.	Size
Packing	12	1kg	1.2kg	0.035	270x160x820mm
10.633					
10.634			800mm		x12 
10.635					
Strong Clip	QTY	N.W	G.W	C.B.M.	Size
Packing	12	1.2kg	1.4kg	0.044	270x160x1020mm
10.636					
10.637			1000mm		x12 
10.638					



3 tamaños,  
3 colores  
disponibles

transparente  
blanco  
negro

## AluGrip

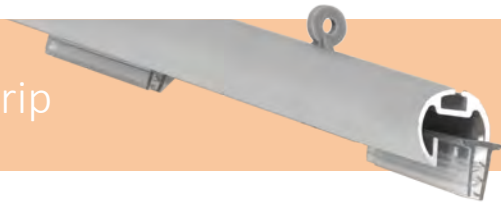

each kit contains:  
2 plastic endcaps  
grippers  
2 hangers  
1 bar

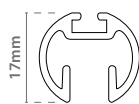

barra extrafina

Alu Grip	QTY	N.W	G.W	C.B.M.	Size
Packing	4	0.31kg	0.5kg	0.0008	50x45x340mm
10.172	300mm	x4 			
Alu Grip	QTY	N.W	G.W	C.B.M.	Size
Packing	4	0.51kg	0.7kg	0.0012	50x45x540mm
10.173	500mm	x4 			
Alu Grip	QTY	N.W	G.W	C.B.M.	Size
Packing	4	0.7kg	0.85kg	0.0017	50x45x740mm
10.174	700mm	x4 			
Alu Grip	QTY	N.W	G.W	C.B.M.	Size
Packing	4	1kg	1.4kg	0.0023	50x45x1040mm
10.175	1000mm	x4 			



## Alu Grip Accessories

Alu Gripper	QTY	N.W	G.W	C.B.M.	Size
Packing	10	0.025kg	0.03kg	0.0005	75x75x90mm
10.176	50mm	x10 			



Alu Hangers	QTY	N.W	G.W	C.B.M.	Size
Packing	10	0.005kg	0.005	0.0005	75x75x90mm
10.178	x10 				



Alu Endcaps	QTY	N.W	G.W	C.B.M.	Size
Packing	10	0.007kg	0.008kg	0.0005	75x75x90mm
10.177	x10 				



Alu Hangers	QTY	N.W	G.W	C.B.M.	Size
Packing	10	0.008kg	0.01kg	0.00004	65x10x65mm
10.179	x10 				



# Poster System

Poster System



## AluPoster



Cada kit contiene

- 1 barra
- 2 Colgadores
- 2 tapas plástico

Alu Poster	QTY	N.W	G.W	C.B.M.	Size
Packing	4	0.4kg	0.6kg	0.0014	80x60x310mm

10.086 300mm x4

Alu Poster	QTY	N.W	G.W	C.B.M.	Size
Packing	4	0.72kg	0.92kg	0.0024	80x60x510mm

10.087 500mm x4

Alu Poster	QTY	N.W	G.W	C.B.M.	Size
Packing	4	1.12kg	1.32kg	0.0038	80x60x810mm

10.088 800mm x4

Alu Poster	QTY	N.W	G.W	C.B.M.	Size
Packing	4	1.48kg	1.68kg	0.0048	80x60x1010mm

10.089 1000mm x4

Alu Poster	QTY	N.W	G.W	C.B.M.	Size
Packing	4	1.68kg	1.88kg	0.0058	80x60x1210mm

10.090 1200mm x4

Alu Poster	QTY	N.W	G.W	C.B.M.	Size
Packing	4	2kg	2.2kg	0.0072	80x60x1510mm

10.091 1500mm x4



## AluPoster Accessories

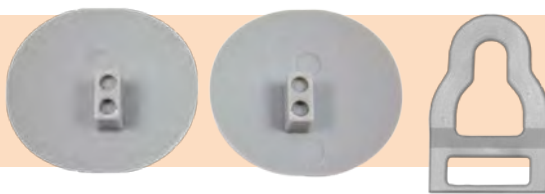

P. Endcap	QTY	N.W	G.W	C.B.M.	Size
Packing	1	0.009kg	0.02kg	0.00004	65x10x65mm

13.399 x10

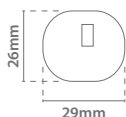

Ring Clip	QTY	N.W	G.W	C.B.M.	Size
Packing	1	0.047kg	0.01kg	0.00004	65x10x65mm

13.400 x10



## AluClip



- 1 bar
- 2 hangers
- 2 plastic endcaps

Alu Clip	QTY	N.W	G.W	C.B.M.	Size
Packing	4	0.35kg	0.5kg	0.0009	65x40x320mm

10.080 300mm x4

Alu Clip	QTY	N.W	G.W	C.B.M.	Size
Packing	4	0.57kg	0.8kg	0.0014	65x40x540mm

10.081 500mm x4

Alu Clip	QTY	N.W	G.W	C.B.M.	Size
Packing	4	0.9kg	1.2kg	0.0022	65x40x840mm

10.082 800mm x4

Alu Clip	QTY	N.W	G.W	C.B.M.	Size
Packing	4	1.2kg	1.5kg	0.0027	65x40x1040mm

10.083 1000mm x4

Alu Clip	QTY	N.W	G.W	C.B.M.	Size
Packing	4	1.4kg	1.8kg	0.0032	65x40x1240mm

10.084 1200mm x4

Alu Clip	QTY	N.W	G.W	C.B.M.	Size
Packing	4	1.7kg	2.2kg	0.004	65x40x1540mm

10.085 1500mm x4



## AluClip Accessories



P. Endcap	QTY	N.W	G.W	C.B.M.	Size
Packing	1	0.009kg	0.02kg	0.00004	65x10x65mm

13.398 x10

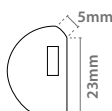



Ring Clip	QTY	N.W	G.W	C.B.M.	Size
Packing	1	0.047kg	0.01kg	0.00004	65x10x65mm

13.400 x10



# Poster System

Poster System  

## Alulon



Cada kit Contiene:

- 1 barra
- 2 colgadores
- 2 tapas plástico



Alulon	QTY	N.W	G.W	C.B.M.	Size
Packing	4	1.2kg	1.4kg	0.0017	540x90x35mm

10.571 500mm x4 

Alulon	QTY	N.W	G.W	C.B.M.	Size
Packing	4	1.8kg	2.1kg	0.0026	90x35x840mm

10.191 800mm x4 

Alulon	QTY	N.W	G.W	C.B.M.	Size
Packing	4	2.2kg	2.6kg	0.0033	90x35x1040mm

10.572 1000mm x4 

Alulon	QTY	N.W	G.W	C.B.M.	Size
Packing	4	2.7kg	3kg	0.0039	90x35x1240mm

10.193 1200mm x4 

Alulon	QTY	N.W	G.W	C.B.M.	Size
Packing	4	3.4kg	3.8kg	0.0049	90x35x1540mm

10.194 1500mm x4 

Alulon	QTY	N.W	G.W	C.B.M.	Size
Packing	4	6.5kg	7.4kg	0.0123	90x45x3025mm

10.195 3000mm x4 

## Alulon Accessories



Colgadores plástico para diferentes perfiles

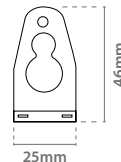

Endcap	QTY	N.W	G.W	C.B.M.	Size
Packing	1	0.009kg	0.02kg	0.0004	65x10x65mm

10.196 Endcap x10 

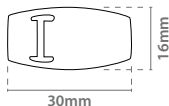

Ring Clip	QTY	N.W	G.W	C.B.M.	Size
Packing	1	0.047	0.01kg	0.00004	65x10x65mm

10.197 RingClip x10 

## FastClip

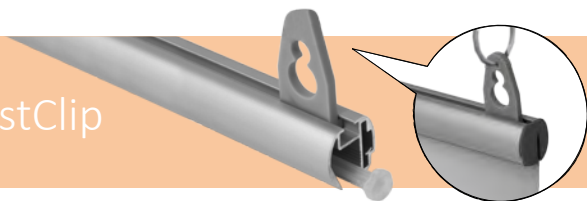

Fast Clip	QTY	N.W	G.W	C.B.M.	Size
Packing	4	0.65kg	0.8kg	0.0018	340x90x60mm

50.600 300mm x4 

Fast Clip	QTY	N.W	G.W	C.B.M.	Size
Packing	4	1.17kg	1.4kg	0.0029	540x90x60mm

50.601 500mm x4 

Fast Clip	QTY	N.W	G.W	C.B.M.	Size
Packing	4	1.7kg	2kg	0.0045	840x90x60mm

50.602 800mm x4 

Fast Clip	QTY	N.W	G.W	C.B.M.	Size
Packing	4	2kg	2.45kg	0.0056	90x60x1040mm

50.603 1000mm x4 

Fast Clip	QTY	N.W	G.W	C.B.M.	Size
Packing	4	2.4kg	2.9kg	0.0067	90x60x1240mm

50.604 1200mm x4 

Fast Clip	QTY	N.W	G.W	C.B.M.	Size
Packing	4	2.9kg	3.5kg	0.0083	90x60x1540mm

50.605 1500mm x4 

## Semi Circular FastClip

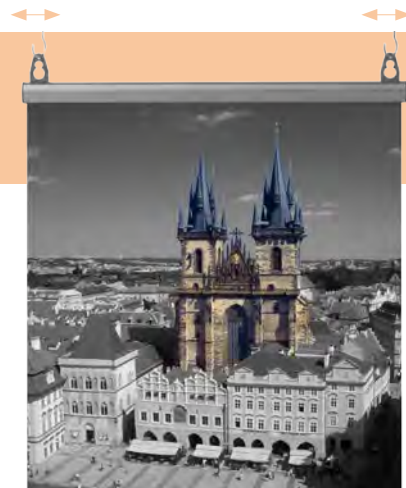
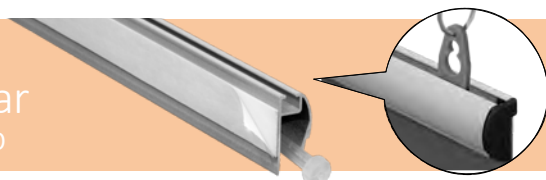

Semi Clip	QTY	N.W	G.W	C.B.M.	Size
Packing	4	0.45kg	0.6kg	0.0015	340x100x45mm

50.606 300mm x4 

Semi Clip	QTY	N.W	G.W	C.B.M.	Size
Packing	4	0.7kg	1kg	0.0024	100x45x540mm

50.607 500mm x4 

Semi Clip	QTY	N.W	G.W	C.B.M.	Size
Packing	1	1kg	1.4kg	0.0038	100x45x840mm

50.608 800mm x4 

Semi Clip	QTY	N.W	G.W	C.B.M.	Size
Packing	4	1.3kg	1.8kg	0.0047	100x45x1040mm

50.609 1000mm x4 

Semi Clip	QTY	N.W	G.W	C.B.M.	Size
Packing	4	1.5kg	2.1kg	0.0056	100x45x1250mm

50.610 1200mm x4 

Semi Clip	QTY	N.W	G.W	C.B.M.	Size
Packing	4	1.95kg	2.5kg	0.0069	100x45x1540mm

50.611 1500mm x4 



# Poster System

Decorail



Decorail

rápido y fácil de montar

**NEW**



- EN The decorail is a profile system composed by an aluminium bar in which they can anchor multiple advertising systems. Ideal for islands and supermarket modules.
- FR Profil en aluminium afin d'y insérer multiples systèmes publicitaires. Idéal pour les supermarchés.
- PT Decorail é um sistema aéreo composto por um perfil de alumínio, do qual se podem suspender vários sistemas publicitários. Ideal para ilhas ou módulos de supermercado.
- ES El decorail es un sistema de perfil aéreo compuesto por una barra de aluminio en la que se pueden anclar múltiples sistemas publicitarios. Ideal para islas y módulos de supermercados.



rápido y sencillo cambio de gráfica

Decorail Aluminium Profile

perfil de aluminio

Deco Alum	QTY	N.W	G.W	C.B.M.	Size
Packing	4	6.5kg	7.4kg	0.0123	90x45x3025mm
50.620	3000mm		x4		

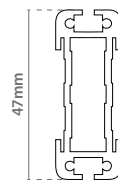

47mm altura perfil

Decorail Endcap



Decorail Ring Hanger

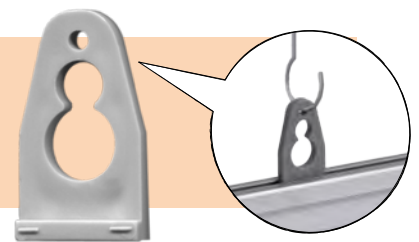

Deco Cap	QTY	N.W	G.W	C.B.M.	Size
Packing	1	0.009kg	0.02kg	0.0004	65x10x65mm
50.622	Endcap		x10		

Ring Hanger	QTY	N.W	G.W	C.B.M.	Size
Packing	10	0.047kg	0.01kg	0.00004	65x10x65mm
10.197			x10		

Decorail Clip Hanger



Deco Clip	QTY	N.W	G.W	C.B.M.	Size
Packing	1	0.009kg	0.02kg	0.0004	65x10x65mm
50.623	Clip Hanger		x10		

# Dispenser Displays

Table display | Wall display | Floor display



**EN** Displays made of transparent plastic for the exhibition and sale of products. Easy and fast to assembly.

**FR** Présentoir fabriqué en plastique transparent pour l'exposition et vente de produits. Distributeur inclus.

**PT** Expositor fabricado em plástico transparente para a exibição ou venda de produtos. Simples e rápido de montar.

**ES** Expositores realizados en plástico transparente para exposición y venta de artículos. Incluyen una o más "bocas" dispensadoras.

## Table Display

con dispensador frontal



rápido y fácil montaje

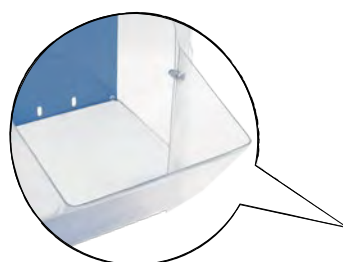
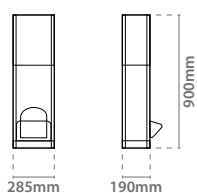

T.Display	QTY	N.W	G.W	C.B.M.	Size
Packing	1	2.5kg	3.6kg	0.058	300x210x920mm
10.475		285x190x900mm			

## Wall Display

with front dispenser

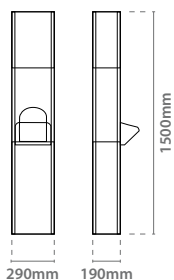

W.Display	QTY	N.W	G.W	C.B.M.	Size
Packing	1	3.7kg	5.46kg	0.1238	335x240x1540mm
10.476		290x190x1500mm			

## Floor Display

con 2 dispensadores

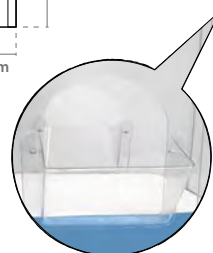
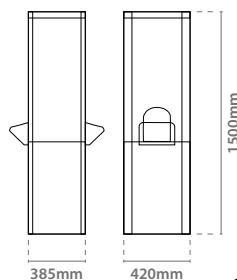

F.Display	QTY	N.W	G.W	C.B.M.	Size
Packing	1	7.35kg	8.2kg	0.27	450x400x1520mm
10.477		420x385x1500mm			

# Dispenser Displays

Promo Square | Easy | Shelf Display  

Promo Square

plástico transparente



**NEW**



1 estante incluido  
2 alturas disponibles:  
240mm  
or 480mm

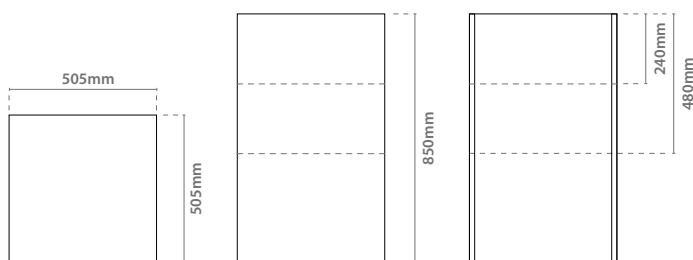

P. Square	QTY	N.W	G.W	C.B.M.	Size
Packing	1	4.35kg	5.1kg	0.02	540x45x900mm
10.440	Recommended Graphic Size: 610x2020mm				

"Easy"

Cartón superior e inferior incluidos

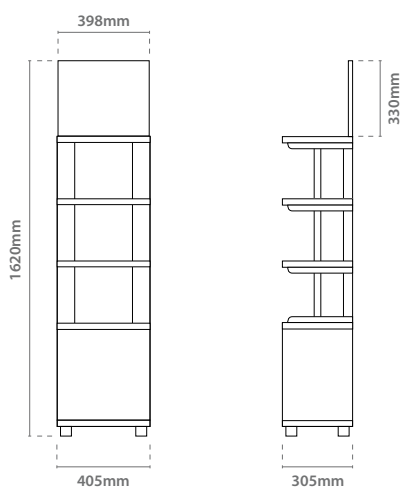



plástico inyectado

base con ruedas



Easy	QTY	N.W	G.W	C.B.M.	Size
Packing	1	4kg	4.8kg	0.0572	520x155x710mm
10.478	305x405x1620mm				

# Dispenser Displays

Promo Shop  

**EN** Display made of injected plastic, for the exhibition and implementation of products. Quick and easy to assemble. The plastic screws and assembling pieces for the billboard can be interchangeable between all display units, depending on the model.

**FR** Présentoir en plastique injecté pour l'exposition et l'implantation de produits. Montage simple et rapide. Les vis en plastique et les pièces du support des visuels sont fournies selon le modèle.

**PT** Expositor em plástico injectado para promoção e implantação de artigos. Montagem fácil e simples. Contém os parafusos de plástico e as peças de fixação necessárias para que a impressão possa ser colocada em qualquer dos módulos, dependendo do modelo.

**ES** Expositor realizado en plástico inyectado para la exposición e implantación de productos. Montaje sencillo y rápido. Los tornillos de plástico y piezas de sujeción de cartelería se suministran con todos los displays, según modelo.

## Promo Shop

rápido y fácil montaje

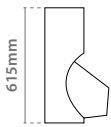

**Promo Shop 1/2**  
10.108

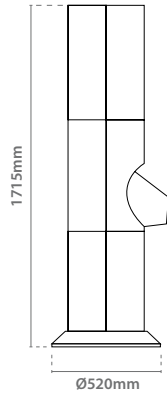
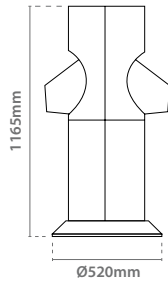
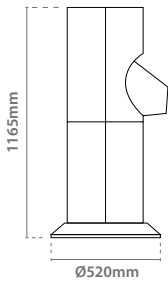

**Promo Shop 1**  
10.109

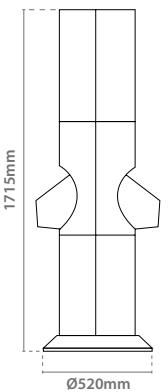

**Promo Shop 2**  
10.102

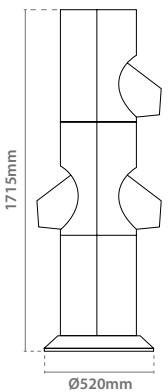

**Promo Shop 3**  
10.103

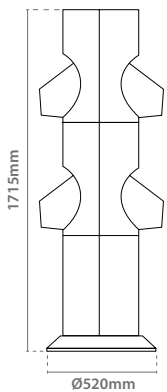

**Promo Shop 4**  
10.104

**Promo Shop 5**  
10.105

**Promo Shop 6**  
10.106

Promo Shop	
10.108	Promo Shop 1/2
10.109	Promo Shop 1
10.102	Promo Shop 2
10.103	Promo Shop 3
10.104	Promo Shop 4
10.105	Promo Shop 5
10.106	Promo Shop 6

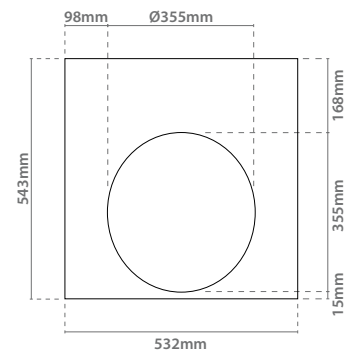

\* Printing / Impression / Impressão / Impresión.

# Dispenser Displays

Promo Shop 

Promo Shop

instrucciones de montaje



- EN**
- Setup:**
- Place the pieces that will hold the graphic in their site (see picture ③).
  - Join the pieces of part ① and ② of the exhibitor.
  - If you want to place the vertical divider, join parts ① and ②, then the exhibitor is being divided into two parts.
  - Place the base (disk piece) on the bottom of the exhibitor.
  - Once the last two steps have been performed, place the screws through the holes.
  - Place the graphic on its correspondent place.
  - Assemble the different modules.
  - Tighten the screws with the nuts.

- FR**
- Montage :**
- Placer les pièces de fixation du visuel comme indiqué sur l'image ③.
  - Unir les parties ① et ② du présentoir.
  - Si vous désirez un séparateur vertical, placé-le lorsque vous unirez les parties ① et ②, vous obtiendrez ainsi un présentoir divisé en deux parties.
  - Emboîter le disque séparateur au fond du présentoir.
  - Une fois les deux étapes antérieures réalisées, mettre les vis dans chaque trou.
  - Placer le visuel.
  - Monter les différents modules.
  - Serrer les vis avec les écrous.

- PT**
- Montagem:**
- Colocar as peças de fixação na impressão de acordo com a imagem ③.
  - Unir as partes ① e ② do expositor.
  - Se desejar o separador vertical, terá de colocá-lo ao unir as partes ① e ②, ficando o expositor dividido ao meio.
  - Encaixar o disco separador no fundo do expositor.
  - Introduzir os parafusos de forma a que atravessam todos os orifícios.
  - Colocar as impressões.
  - Montar os diferentes módulos.
  - Apertar os parafusos com as respectivas porcas.

- ES**
- Montaje:**
- Colocar las piezas de sujeción de cartelería, (ver fotografía ③).
  - Unir las partes ① y ② del expositor.
  - Si desea separador vertical colocar al unir las partes ① y ②, quedando entonces el expositor dividido en dos partes.
  - Encajar el disco separador como base en el fondo del expositor.
  - Una vez realizados los dos pasos anteriores colocar los tornillos, atravesando todos los agujeros.
  - Colocar las gráficas.
  - Montar los distintos módulos.
  - Apretar los tornillos con las tuercas.

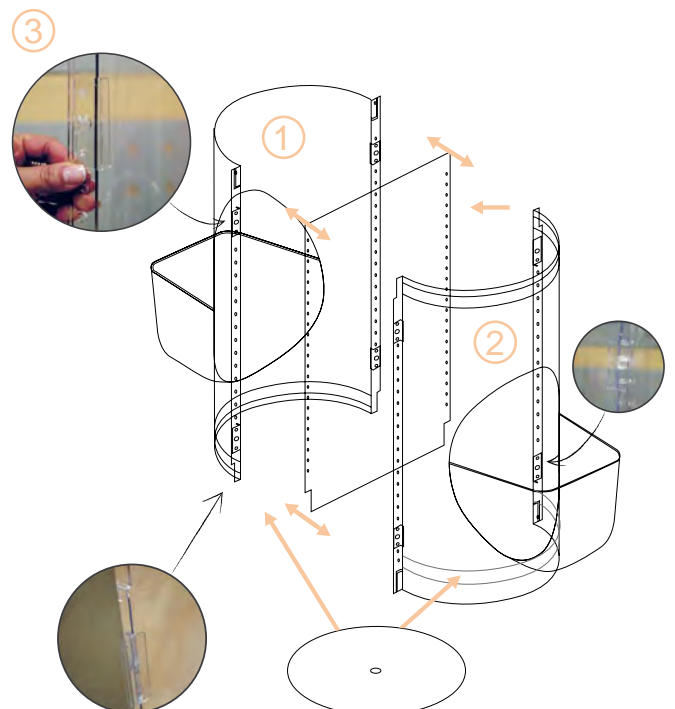
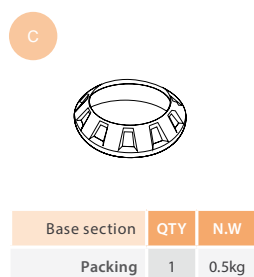
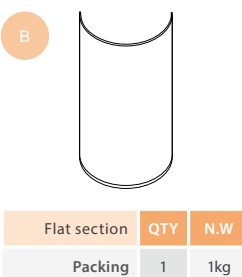
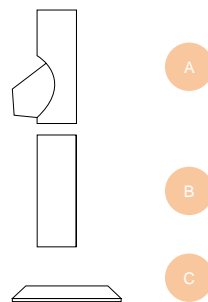
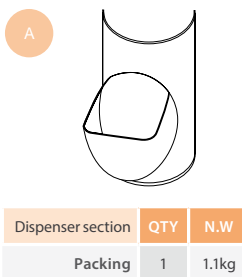

# Dispenser Displays

Wooden Promo Bowl | Promo Net Bowl



**EN** Exhibitors made of plastic, for the display and introduction of products. Fast and easy to assemble.  
**FR** Présentoir en plastique pour l'exposition et vente du produit. Facile et rapide à monter.

**PT** Expositor em plástico para promoção e implantação de artigos. Montagem fácil e simples.  
**ES** Expositores de plástico, para la implantación y exhibición de productos. Fácil y rápido de montar.

## Wooden Promo Bowl

semiesfera transparente

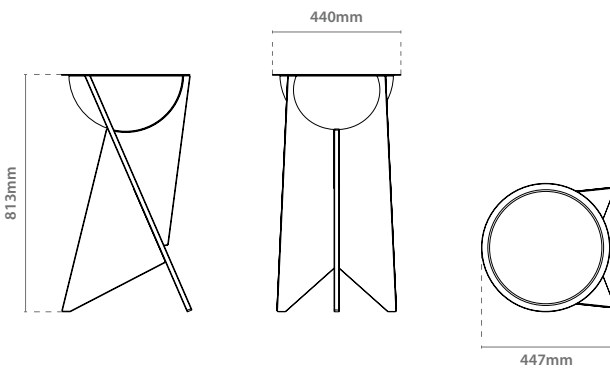
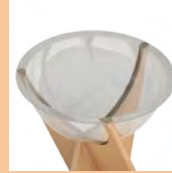

W. Promo	QTY	N.W	G.W	C.B.M.	Size
Semisphere	1	0.75kg	1.85kg	0.0561	492x485x235mm
Wood Base	1	4.95kg	5.75kg	0.0196	900x435x50mm
13.481		Natural Wood			

## Aluminium Promo Bowl

semiesfera transparente

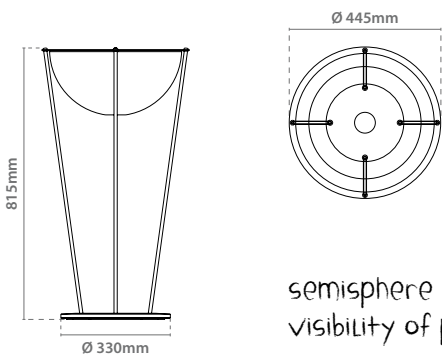
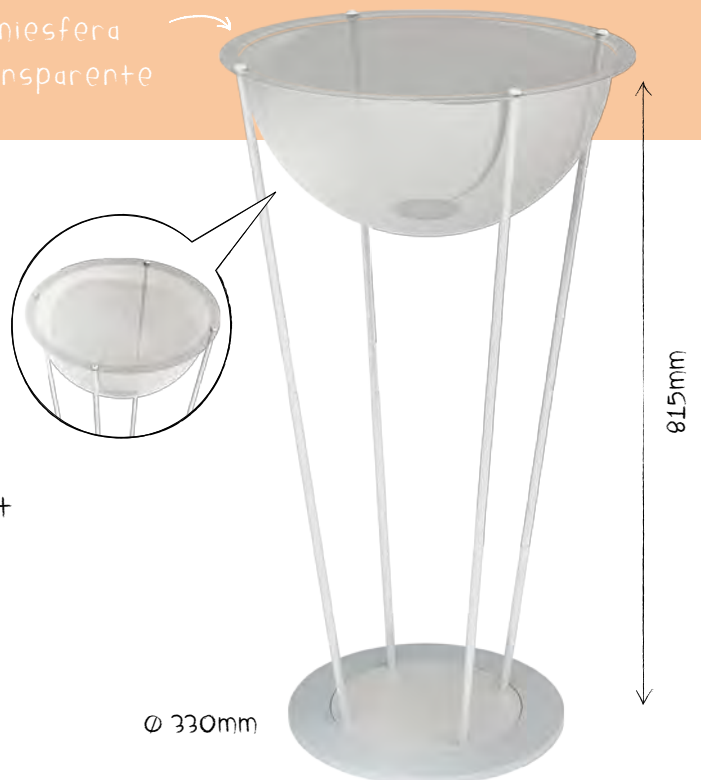

semisphere allows a great visibility of product

A. Promo	QTY	N.W	G.W	C.B.M.	Size
Semisphere	1	1.15kg	2.35kg	0.0561	492x485x235mm
Base	1	5kg	5.3kg	0.0055	350x350x45mm
50.383		Semisphere: Ø 445mm   Base: Ø 330mm			

# Dispenser Displays

Promo Bowl  

Promo Bowl

**NEW**

4 semiesferas transparentes

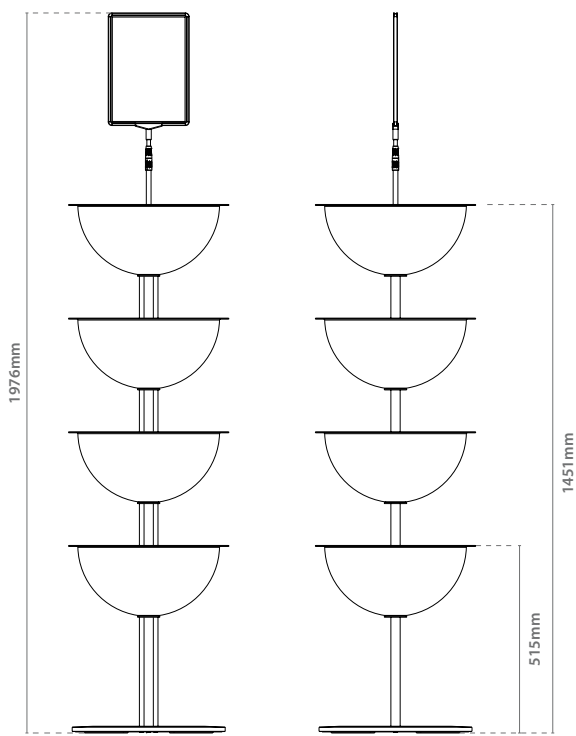

semiesferas de  
Ø 440mm

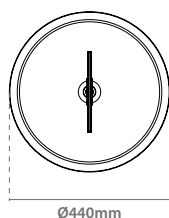

Promo Bowl	QTY	N.W	G.W	C.B.M.	Size
Semisphere	1	2.95kg	3.95kg	0.0714	455x455x345mm
Base+Profile	1	9kg	10kg	0.0714	455x455x345mm
10.802	Semisphere: Ø 440mm				



# Dispenser Displays

Promo Cash | Promo Brand



Promo Cash



rápido y fácil montaje

muy ligero para transportar

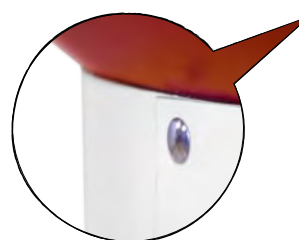
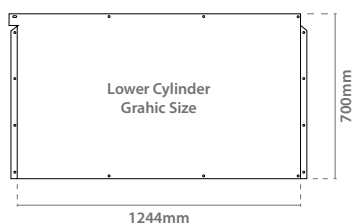
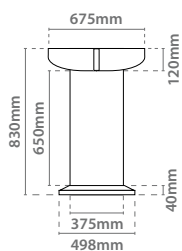

Promo Cash

13.468

Graphic Size: 1244x700mm

Promo Brand

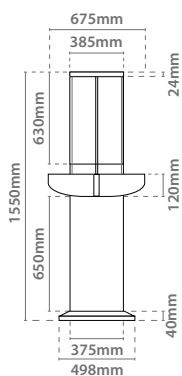

totalmente desmontable

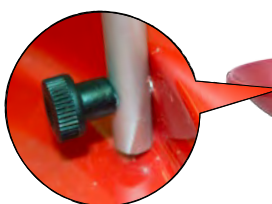
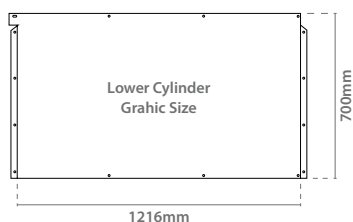

Promo Brand

10.429

Graphic Size: 1216x700mm



# Dispenser Displays

Promo Store  

Promo Store

disponible en color azul y rojo





un divisor permite 2 productos diferentes

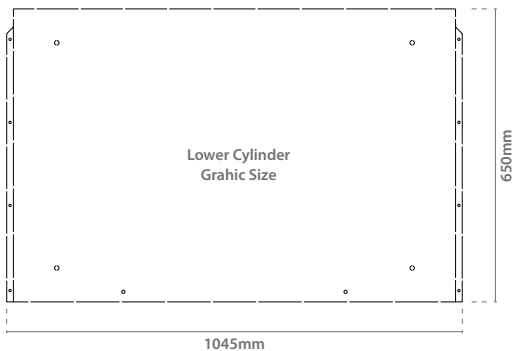
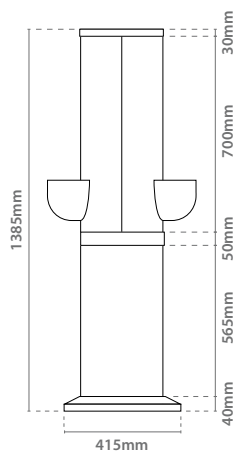

simple y rápido de instalar



gráfica del cilindro inferior:  
1045x650mm

Promo Store	QTY	N.W	G.W	C.B.M.	Size
Packing	1	2.58kg	3.93kg	0.1762	450x440x880mm
10.110	 	Graphic Size: 1045x650mm			



# Dispenser Displays

Multifunction Shelf Tineo



Multifunction Shelf Tineo

muy ligero para transportar

**NEW**

Patent System

fácilmente personalizable



useful space

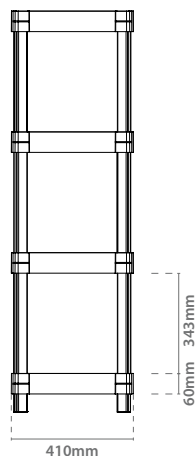
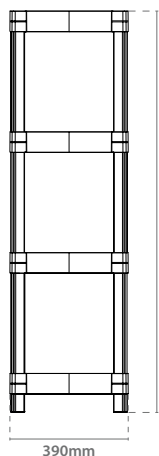
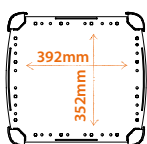

60mm 343mm

elige tu propia configuración

1 4 colores de postes disponibles



2 colores de estantes disponibles

**2**

Multi Shelf	QTY	N.W	G.W	C.B.M.	Size
Packing	1	5.65kg	6.15kg	0.05712	420x400x340mm
Pole	<input type="checkbox"/>	<input checked="" type="checkbox"/>	<input checked="" type="checkbox"/>	<input checked="" type="checkbox"/>	
Shelf	<input type="checkbox"/>	<input checked="" type="checkbox"/>	<input checked="" type="checkbox"/>		
13.473		390x410x1173mm			

# Dispenser Displays

Multifunction Shelf Tineo Personalization Possibilities



fácil y rápido de montar



- EN Possibility of adding one or more graphics on any side.
- FR Possibilité d'ajouter une ou plus visuels sur les côtés.
- PT Pode-se adicionar uma ou mais imagens sobre os lados.
- ES Posibilidad de incorporar una o más gráficas en los laterales.



- EN Possibility of turning into a cabinet display by panels.
- FR Peut se transformer en vitrine avec l'utilisation des panneaux.
- PT Pode-se transformar em vitrina através do uso de painéis.
- ES Posibilidad de convertir en vitrina mediante el uso de paneles.

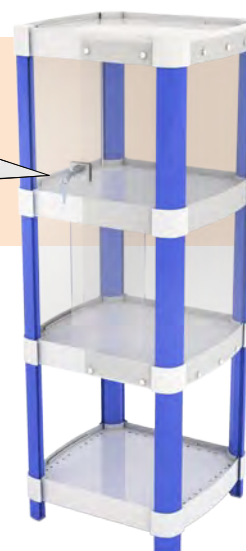

graphic casing

cabinet display

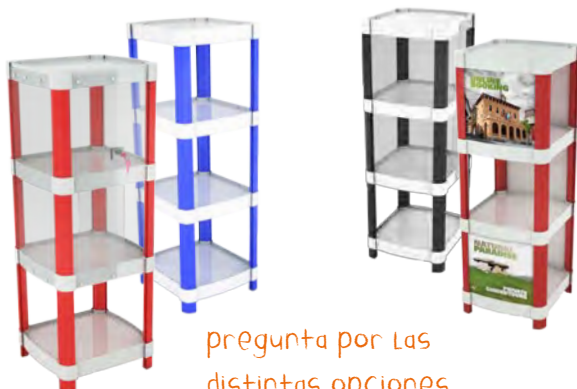

pregunta por las distintas opciones de personalización

totalmente desmontable

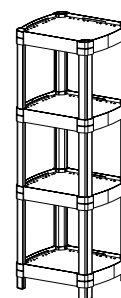
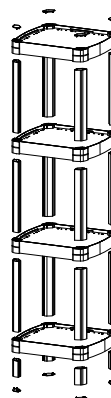

Wheels for Multifunction Shelf Display



conviértelo fácilmente a display móvil

también disponible patas regulables



Wheels	QTY	N.W	G.W	C.B.M.	Size
Packing	4	0.3kg	0.35kg	0.0008	130x105x60mm
14.102	2 Wheels + 2 Brake Wheels			x4	

\* For detailed information about these and others available configurations, enquire us. / \* Pour des informations plus détaillées sur ces ou des autres configurations, contactez-nous. / \* Para información detallada sobre éstas y otras configuraciones disponibles, consúltenos. / \* Para informação mais detalhada sobre estas ou outras configurações, contacte-nos.





# Dispenser Displays

Shelf Display | Wire Dumpbin  

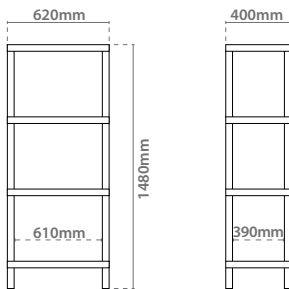
## Shelf Display

totalmente  
desmontable



S.Display	QTY	N.W	G.W	C.B.M.	Size
Packing	1	8kg	8.45kg	0.073	400x290x630mm
10.384		617x400x1480mm			
10.386					
10.387					
10.388					

4 colores  
de estantes  
disponibles

## Wire Dumpbin

**NEW**

realizado en  
acero

3 tamaños disponibles

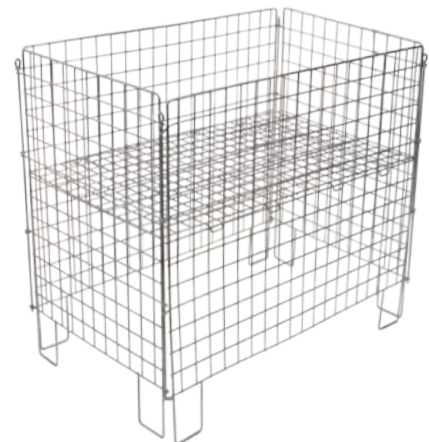
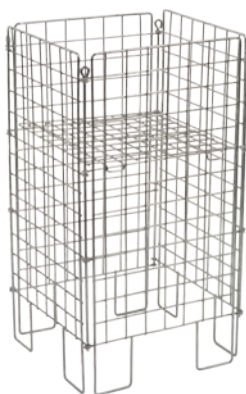

W.Dump	QTY	N.W	G.W	C.B.M.	Size
Packing	1	7.2kg	8.4kg	0.2	795x425x550mm
50.350	400x400x770mm				

W.Dump	QTY	N.W	G.W	C.B.M.	Size
Packing	1	8.8kg	10.2kg	0.27	795x620x550mm
50.351	600x400x770mm				

W.Dump	QTY	N.W	G.W	C.B.M.	Size
Packing	1	13.6kg	15.2kg	0.52	1205x790x550mm
50.352	1000x600x770mm				

# Turntables

Turntables 

EN Rotary and pendulum 360° motors for product exhibition. Different loads and features (LED, solar, batteries, etc.).  
FR Moteurs pendulaires ou de giratoires (360°) avec différentes capacités ou caractéristiques (led, énergie solaire, batteries...).

PT Motores pendulares ou giratório (360°) com diferentes capacidades ou características (com led, a energia solar, pilhas...).  
ES Motores giratorios 360° y pendulares para exhibición de producto. Diferentes prestaciones según modelo (LED, solar, baterías, etc.).



Turntable  
±20kg | Ø410mm

Color  
blanco

±20  
kg

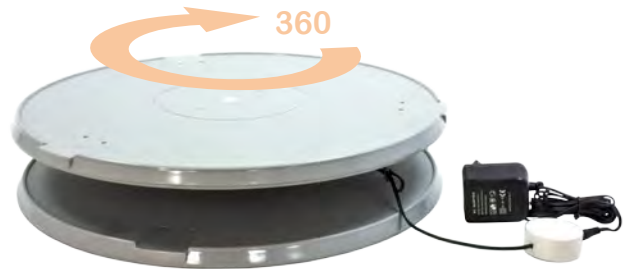

Turntable	QTY	N.W	G.W	C.B.M.	Size
Packing	1	1.9kg	2.15kg	0.015	420x90x420mm
10.987			Ø410x80mm		

Turntable  
±20kg | Ø200mm

Turntable  
±3kg | Ø130mm

Color  
blanco



±20  
kg

Turntable	QTY	N.W	G.W	C.B.M.	Size
Packing	1	0.75kg	0.9kg	0.0048	225x75x285mm
10.986			Ø200x60mm		



±3  
kg

Turntable	QTY	N.W	G.W	C.B.M.	Size
Packing	1	0.4kg	0.5kg	0.0025	150x70x240mm
10.518			Ø130x57mm		

# Turntables

Turntables  

Solar  
Pendulum Display  $\pm 5g$



$\pm 5g$

funciona con  
energía solar

SolarPendul.	QTY	N.W	G.W	C.B.M.	Size
Packing	1	0.04kg	0.05kg	0.0002	55x30x105mm
10.358		100x50x30mm			

Battery  
Pendulum Display  $\pm 14g$



$\pm 14g$

funciona con 2 pilas AA  
no incluidas

Batt.Pendul.	QTY	N.W	G.W	C.B.M.	Size
Packing	1	0.11kg	0.14kg	0.0006	75x50x165mm
10.063		160x70x43mm			

Battery Turntable  
 $\pm 200g$  |  $\varnothing 85mm$



$\pm 200g$

funciona con 1 pila AA  
no incluida

BatteryTurn	QTY	N.W	G.W	C.B.M.	Size
Packing	1	0.12kg	0.15kg	0.0001	95x89x125mm
10.406		$\varnothing 85x45mm$			

Solar Turntable  
 $\pm 200g$

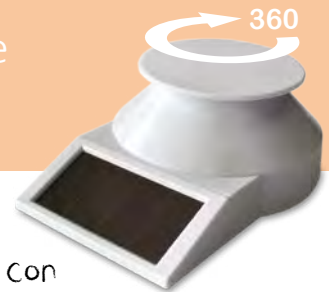

$\pm 200g$

funciona con  
energía solar

SolarTurn	QTY	N.W	G.W	C.B.M.	Size
Packing	1	0.08kg	0.1kg	0.0004	85x45x115mm
10.064		112x80x43mm			

Battery Turntable  
 $\pm 2kg$  |  $\varnothing 85mm$





$\pm 2kg$

4 LEDs included  
works with batteries  
or directly plugged in



$\pm 2.5kg$

función de giro funciona solo enchufado

Led Turntable	QTY	N.W	G.W	C.B.M.	Size	LED	🔌
Packing	1	0.3kg	0.35kg	0.002	125x75x190mm		
10.407			$\varnothing 80x45mm$				

Led Turntable	QTY	N.W	G.W	C.B.M.	Size	LED	🔌
Packing	1	0.4kg	0.45kg	0.0013	127x55x197mm		
10.456		$\varnothing 107x45mm$					