

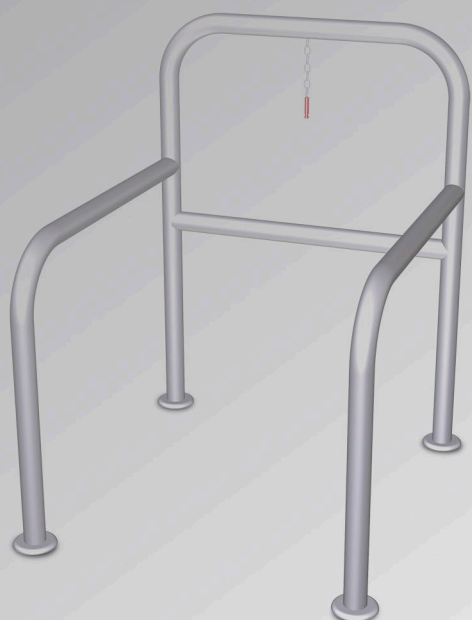

8
1
0
2



acero
inoxidable

PLETINA, TUBO y SOPORTES INOX

Pletinas

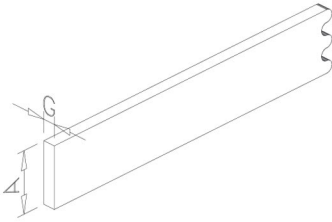

A	G	Gr	Barcode
20	5	800	407808
30	5	1.200	407811
40	5	1.600	407816
40	6	1.920	407820
40	8	2.560	407828
40	10	3.200	407838
50	8	3.200	407832

Concepto	Barcode
Corte a medida	021004
Taladro	021002



Peso por metro.

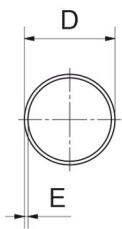

Tubos

D	E	Gr	Barcode
10	1,0	227	406810
16	1,0	377	406824
20	1,5	695	407013
25	1,0	600	406832
25	1,5	885	407020
30	1,5	1.070	407028
30	2,0	1.400	407206
35	1,5	1.195	407036
38	1,5	1.370	407040
43	1,5	1.475	407048
76,10	2,0	3.730	407060

Concepto	Barcode
Corte a medida	021004
Tapar extremos inox	021202



Peso por metro.

Existen tapones de plástico para tapar los extremos del tubo.

Ganchos cartela fijo y giratorio

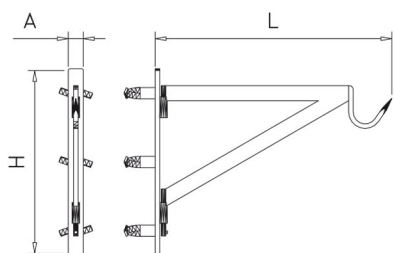

Fijación	H	A	L	Kg	Barcode
Atornillar	495	40	630	5,3	023802
Recibir Fix to the wall Adosser dans le mur	495	40	630	5,4	023804

Soporte cartela fijo y giratorio para balanzas

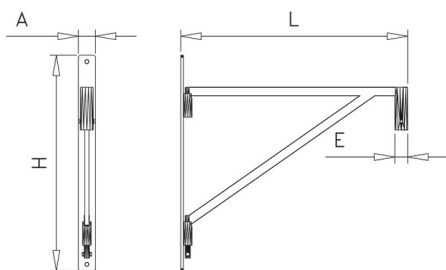

H	A	L	E	Kg	Barcode
450	40	535	30	1,55	024002

Kit para colgar utensilios

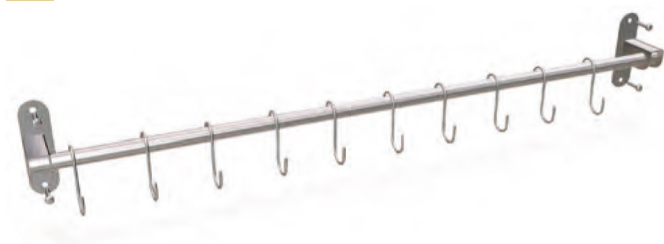

Características:

Construido totalmente en acero inoxidable.
Gran resistencia.
Provisto de 10 ganchos (022502).
Incluye tornillos y tacos para fijar a la pared.
Libera superficie de trabajo en la encimera.
También se puede usar como toallero o para colgar las tapas de las cubetas y las ollas.



L	A	H	Gr	Barcode
750	50	100	500	020102

H	E	D	Barcode
---	---	---	---------

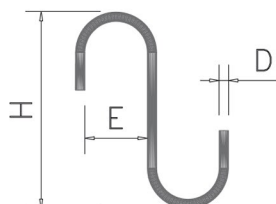

60	16	3	022502
----	----	---	--------



Gancho opcional.

Barra mural con ganchos

Características:

Pletina de 40x8 mm.
 Pletina pulida a las cuatro caras.
 Ganchos móviles.
 Posibilidad de añadir y quitar ganchos.
 Dos robustos soportes para la sujeción a pared.

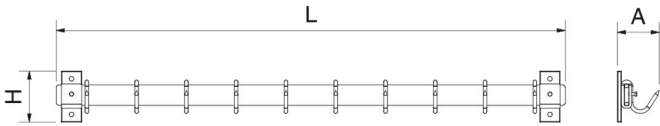

L	A	H	Nº Ganchos Hooks Crochets	Kg	Barcode
1.000	90	100	10	3,00	024220
1.500	90	100	10	4,00	024222

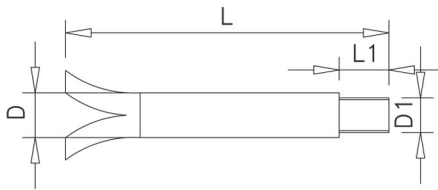

L	D	L1	D1	Gr	Barcode
150	18	20	M14	205	029802
200	18	20	M14	300	029804
250	18	20	M14	400	029806



Tochos de hierro cincado rosca métrica



H	A	L	E	Gr	Barcode
100	40	18	10	345	024402

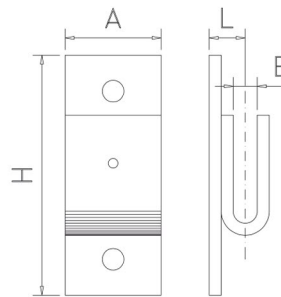

Soporte central



H	A	L	E	Gr	Barcode	Barcode
100	40	45	10	345	024602	024604

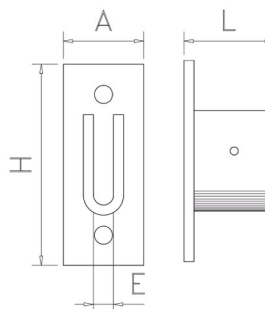

Soporte lateral



Soportes laterales para tubo

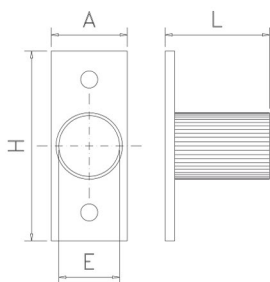

H	A	L	E	Gr	Barcode
100	40	45	30	190	026202
100	40	45	38	200	026204

Soportes rectos para recibir

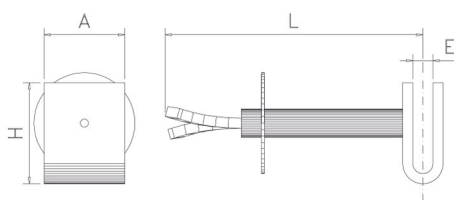

H	A	L	E	Gr	Barcode
50	40	130	10	320	024802
50	40	180	10	350	024804
50	40	230	10	455	024806

Soportes rectos en tubo para recibir

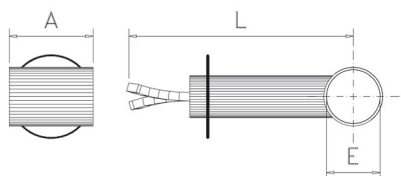

A	L	E	Gr	Barcode
60	130	30	218	026402
		38	233	026404
60	180	30	248	026406
		38	263	026408
60	230	30	313	026410
		38	328	026412

Plafones para exposición de embutidos

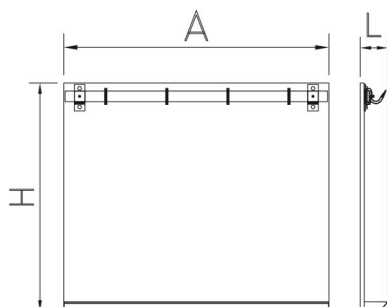

Gancho opcional. 02160

A	L	H	Nº Ganchos Hooks Crochets	Kg	Barcode
800	110	865	3	10	024202
1.000	110	865	4	11	024204
1.500	110	865	5	15	024206

Soportes puente con trasera



H	A	L	E	Gr	Barcode
200	40	140	10	975	025002
290	40	240	10	1.385	025004

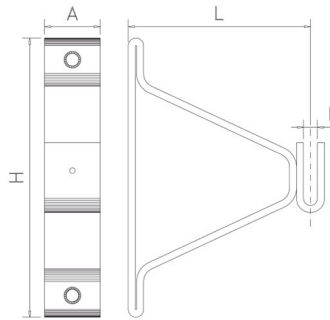

Soportes puente sin trasera



H	A	L	E	Gr	Barcode
200	40	135	10	645	025202
290	40	235	10	935	025204

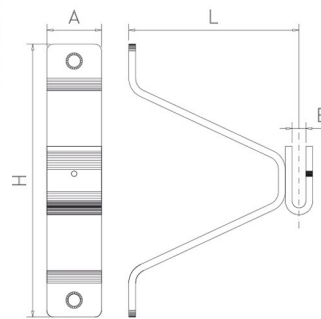

Soportes rectos

H	A	L	E	Gr	Barcode
100	40	50	10	325	025402
100	40	100	10	400	025404
100	40	150	10	475	025406
100	40	200	10	550	025408

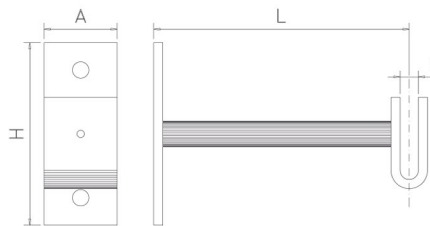

Soportes puente con trasera para tubo

H	A	L	E	Gr	Barcode
200	40	145	30	840	026602
		149	38	855	026604
290	40	245	30	1.285	026606
		249	38	1.300	026608

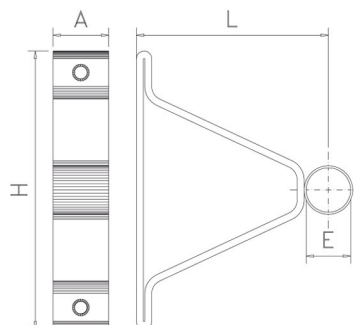

Soportes puente sin trasera para tubo

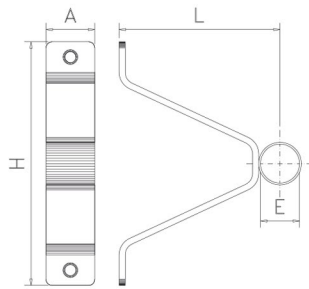

H	A	L	E	Gr	Barcode
200	40	140	30	540	026802
		144	38	550	026804
290	40	240	30	845	026806
		244	38	855	026808

Soportes rectos para tubo

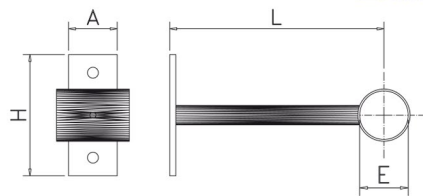

H	A	L	E	Gr	Barcode
100	40	50	30	220	027002
			38	280	027004
100	40	100	30	295	027006
			38	310	027008
100	40	150	30	370	027010
			38	385	027012
100	40	200	30	445	027014
			38	460	027016

Cartelas abatibles para estantes murales



***HASTA 100 Kg**
por cartela

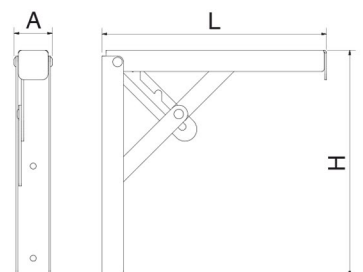

Acoplar a estante inox	013204
Acoplar a estante fibra	013202

L	A	H	Kg	Barcode
200	30	185	0,33	421254

Tirantes de techo



Cada 50 mm. de más o fracción aumentará 2 Euros..

H	A	L	E	Gr	Barcode
100	40	100	10	360	025602
150	40	100	10	380	025604
200	40	100	10	400	025606
250	40	100	10	420	025608
300	40	100	10	440	025610
350	40	100	10	460	025612
400	40	100	10	480	025614
450	40	100	10	500	025616
500	40	100	10	520	025618
550	40	100	10	540	025620
600	40	100	10	560	025622
650	40	100	10	580	025624
700	40	100	10	600	025626
750	40	100	10	620	025628
800	40	100	10	640	025630
850	40	100	10	660	025632
900	40	100	10	680	025634
950	40	100	10	690	025636
1.000	40	100	10	695	025638

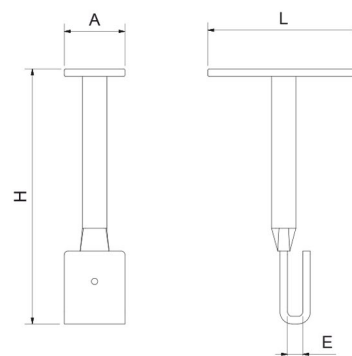
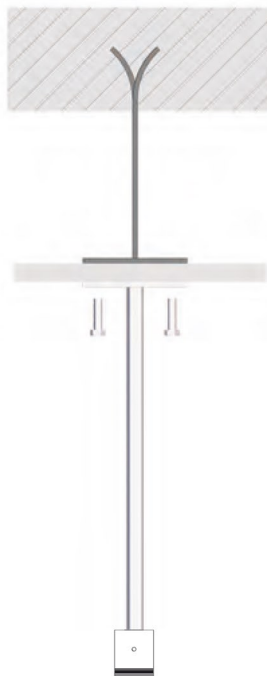

Tirantes de techo con varilla roscada



Cada 50 mm. de más o fracción aumentará 2 Euros..

H	h	E	D	Gr	Barcode
100	150	10	M14	410	025802
150	150	10	M14	430	025804
200	150	10	M14	450	025806
250	150	10	M14	470	025808
300	150	10	M14	490	025810
350	150	10	M14	510	025812
400	150	10	M14	530	025814
450	150	10	M14	550	025816
500	150	10	M14	570	025818
550	150	10	M14	590	025820
600	150	10	M14	600	025822
650	150	10	M14	650	025824
700	150	10	M14	700	025826
750	150	10	M14	750	025828
800	150	10	M14	800	025830
850	150	10	M14	850	025832
900	150	10	M14	900	025834
950	150	10	M14	950	025836
1.000	150	10	M14	1.000	025838

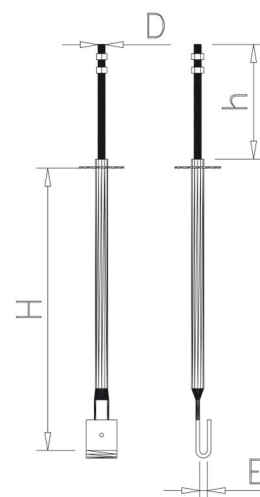

Tirantes de techo para tubo

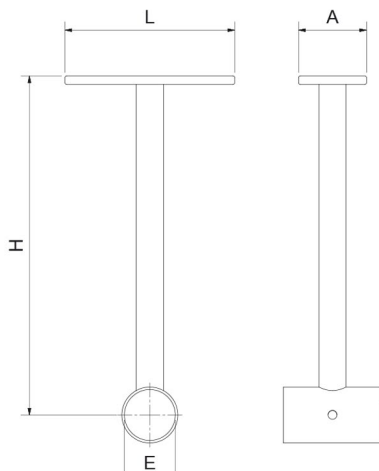
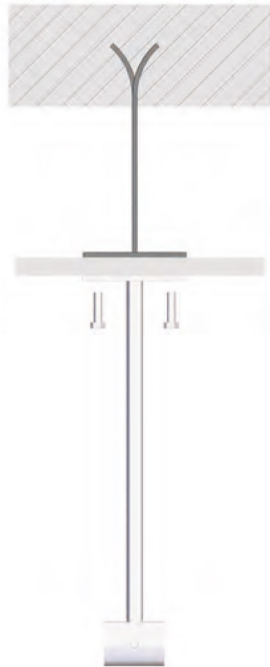

Cada 50 mm. de más o fracción aumentará 2 Euros.

H	A	L	E	Gr	Barcode
100	40	100	30	300	027202
			38	320	027204
150	40	100	30	330	027206
			38	350	027208
200	40	100	30	360	027210
			38	380	027212
250	40	100	30	390	027214
			38	410	027216
300	40	100	30	420	027218
			38	440	027220
350	40	100	30	450	027222
			38	470	027224
400	40	100	30	480	027226
			38	500	027228
450	40	100	30	510	027230
			38	530	027232
500	40	100	30	540	027234
			38	560	027236
550	40	100	30	570	027238
			38	590	027240
600	40	100	30	600	027242
			38	620	027244
650	40	100	30	630	027246
			38	650	027248
700	40	100	30	660	027250
			38	680	027252
750	40	100	30	690	027254
			38	710	027256
800	40	100	30	720	027258
			38	740	027260
850	40	100	30	750	027262
			38	770	027264
900	40	100	30	780	027266
			38	800	027268
950	40	100	30	810	027270
			38	830	027272
1.000	40	100	30	840	027274
			38	860	027276

Tirantes de techo para tubo con varilla roscada

H	h	D	E	Gr	
100	150	M14	30	350	027402
			38	370	027404
150	150	M14	30	380	027406
			38	400	027408
200	150	M14	30	410	027410
			38	430	027412
250	150	M14	30	440	027414
			38	460	027416
300	150	M14	30	470	027418
			38	490	027420
350	150	M14	30	500	027422
			38	520	027424
400	150	M14	30	530	027426
			38	550	027428
450	150	M14	30	560	027430
			38	580	027432
500	150	M14	30	590	027434
			38	610	027436
550	150	M14	30	620	027438
			38	640	027440
600	150	M14	30	650	027442
			38	670	027444
650	150	M14	30	680	027446
			38	700	027448
700	150	M14	30	710	027450
			38	730	027452
750	150	M14	30	740	027454
			38	760	027456
800	150	M14	30	770	027458
			38	790	027460
850	150	M14	30	800	027462
			38	820	027464
900	150	M14	30	830	027466
			38	850	027468
950	150	M14	30	860	027470
			38	880	027472
1.000	150	M14	30	890	027474
			38	910	027476

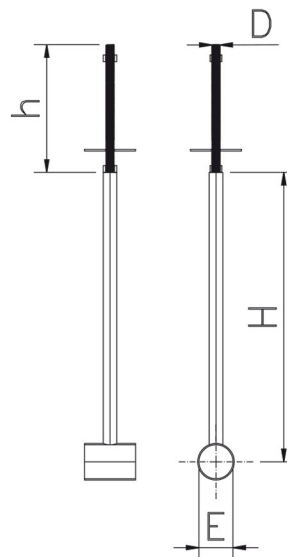

Cada 50 mm. de más o fracción aumentará 2 Euros.

Sujeciones de hierro para tirante

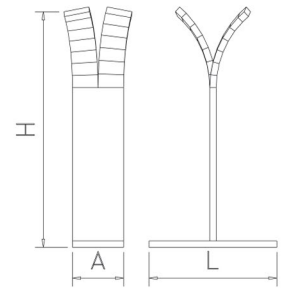
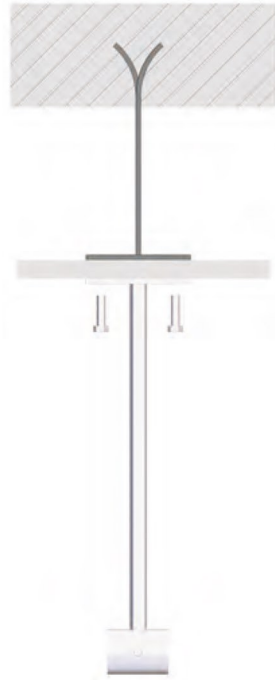

H	A	L	Gr	Barcode
100	40	100	240	028402
200	40	100	360	028404
300	40	100	480	028406
400	40	100	600	028408
500	40	100	720	028410
600	40	100	840	028412
700	40	100	960	028414
800	40	100	1.080	028416
900	40	100	1.200	028418
1.000	40	100	1.320	028420

Garras galvanizadas para tirantes

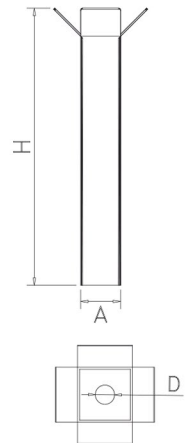
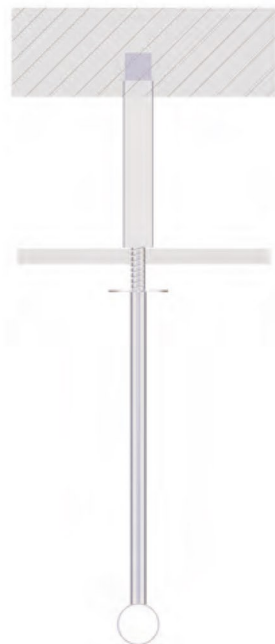

H	A	D	Gr	Barcode
100	40	M14	170	028602
200	40	M14	340	028604
300	40	M14	510	028606
400	40	M14	680	028608
500	40	M14	850	028610
600	40	M14	1.020	028612
700	40	M14	1.190	028614
800	40	M14	1.360	028616
900	40	M14	1.530	028618
1.000	40	M14	1.700	028620

Tirante para balanzas regulable

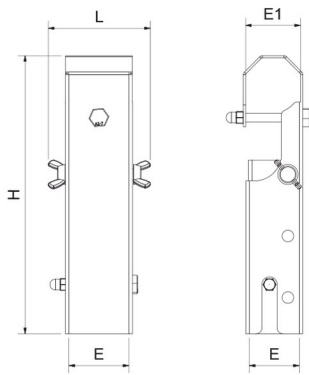

Características:

Diseñado para adaptar la altura de la balanza a cada usuario. La regulación se realiza de una manera fácil, rápida y segura, sin tener que descolgar o desenchufar la balanza. Regulación 86 mm. Para tubo de $\varnothing 38$ mm. arriba. Casquillo de $\varnothing 40$ mm. en balanza.

H	L	E	E1	Gr	Barcode
192-234-277	70	$\varnothing 40$	$\varnothing 38$	500	028250

H	E	E1	Gr	Barcode
100	30	30	110	028202
		38	120	028204
200	30	30	215	028206
		38	225	028208
300	30	30	320	028210
		38	330	028212
400	30	30	425	028214
		38	435	028216
500	30	30	530	028218
		38	540	028220
600	30	30	635	028222
		38	645	028224
700	30	30	740	028226
		38	750	028228
800	30	30	845	028230
		38	855	028232
900	30	30	950	028234
		38	960	028236
1.000	30	30	1.055	028238
		38	1.065	028240

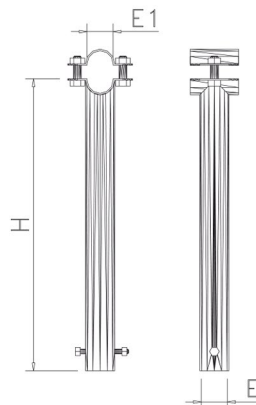

Defensa de esquina tubular 90°



Características:

Desmontable.
Fabricadas en tubo de $\varnothing 48.3$ mm.
AISI 304.
Fijación mediante casquillos.

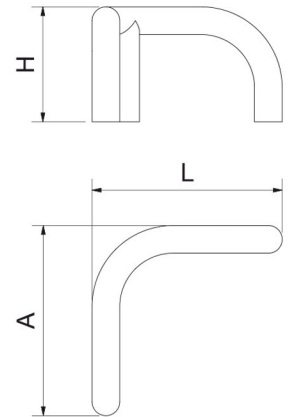

H	A	L	Gr	Barcode
220	340	340	1.150	425402

Soportes de suelo

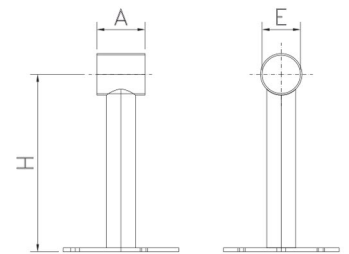
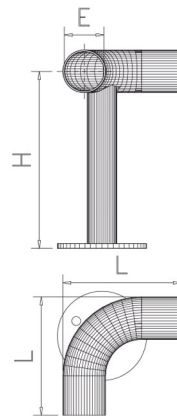

H	L	E	Gr	Barcode
200	90	30	695	029002
	210	38	990	029004
250	90	30	745	029006
	210	38	1.040	029008
300	90	30	795	029010
	210	38	1.090	029012

H	A	E	Gr	Barcode
200	50	30	600	028802
		38	630	028804
250	50	30	650	028806
		38	680	028808
300	50	30	700	028810
		38	730	028812

Aparcamiento para carros

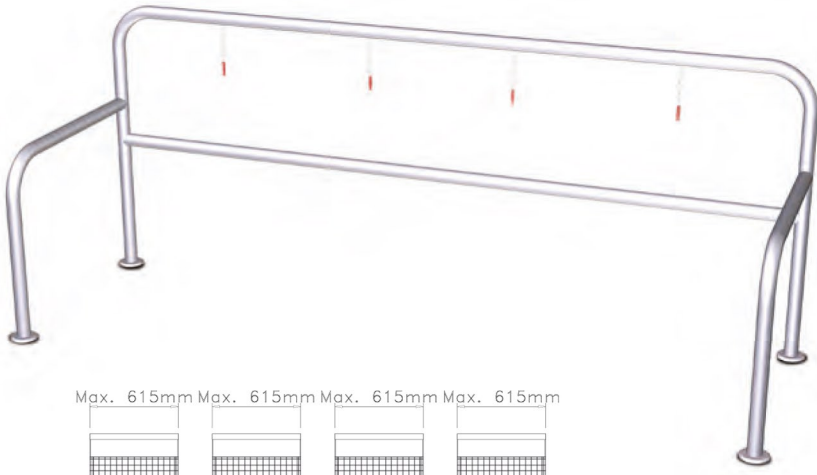

Max. 615mm Max. 615mm Max. 615mm Max. 615mm

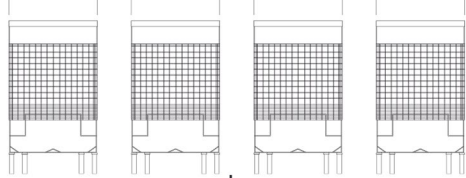

Max. 615mm

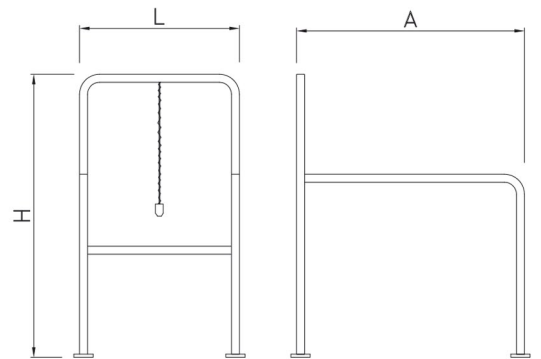
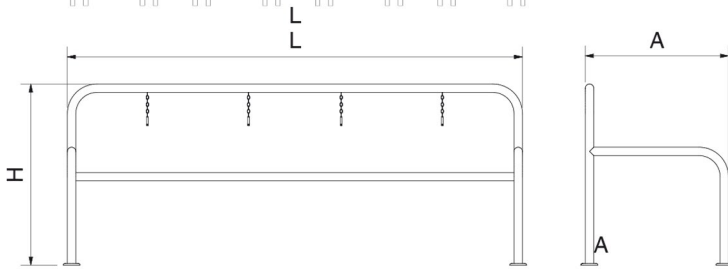
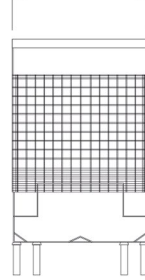

L	A	H			
800	800	1.100	1	5,50	420602
1.800	800	1.100	2	7,50	420606
2.000	800	1.100	3	10,50	420608
2.700	1.000	1.100	4	12,00	420604



H	L	A		
100	40	5	135	224602

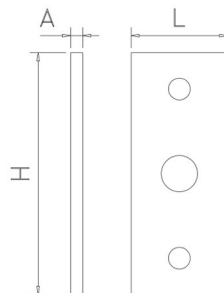

Plaqueta



D	d	A		
120	30	4	340	228806

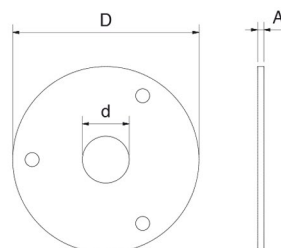

Plaqueta redonda



Soporte jamón RT



Novedad
en
nouveau

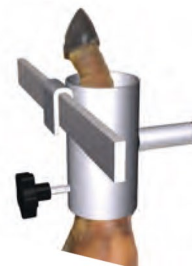
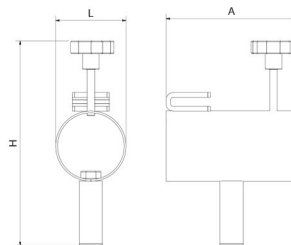

L	A	H	Gr	Barcode
75	140	220	800	041812

Útil para sujeción de jamones

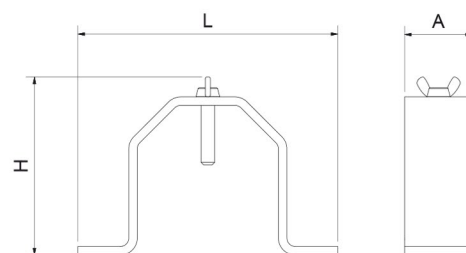

L	A	H	Gr	Barcode
153	40	105	400	024250

Tubos en escuadra

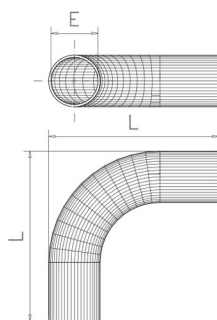

E	L	Gr	Barcode
30	90	195	429002
38	210	490	429004

Tubos en forma de " T "

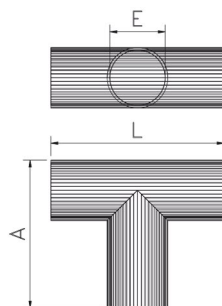

E	L	A	Gr	Barcode
30	110	70	160	425002
38	100	70	185	425004

Cruces para tubo

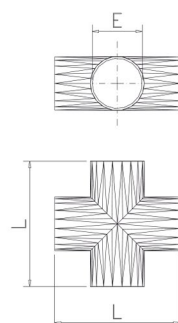

E	L	Gr	Barcode
30	112	210	425202
38	110	340	425204

" U " sencilla

H	A	E	Gr	Barcode
50	40	10	155	029606

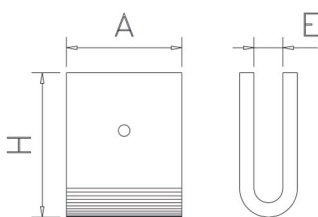

" U " en doble T



H	A	L	E	Gr	Barcode
50	40	100	10	445	029202

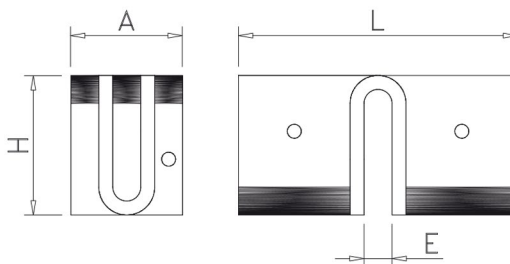

" U " en forma de T



H	A	L	E	Gr	Barcode
50	40	50	10	295	029402

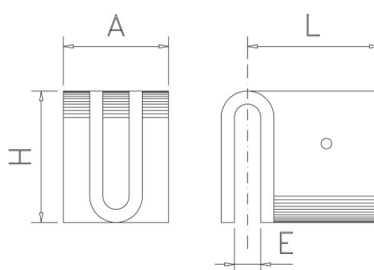

" U " mixta en forma de T



H	A	L	E	E1	Gr	Barcode
50	40	60	10	30	175	029302
50	40	60	10	38	180	029304

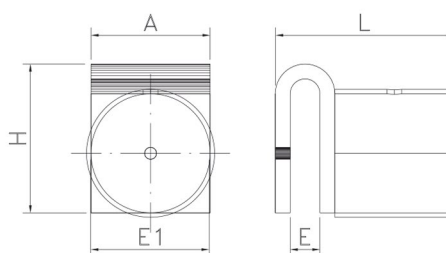

	EN	FR	PT	ES										
	Carry bag included	Avec sac de transport	Inclui bolsa de transporte	Incluye bolsa de transporte		With Adhesive	Avec adhésif	Con adesivo	Con adhesivo		Portrait / Landscape	Vertical ou horizontal	Vertical ou horizontal	Vertical u Horizontal
	One sided	Une face	Uma face	Una cara		Cardboard	Carton	Cartão	Cartón		"Click" System	Système "Click"	Sistema "Click"	Sistema "Click"
	Double-Sided	Double face	Dupla face	Doble cara		With suction pad	Avec ventouse	Com ventosa	Con ventosa		With Velcro	Avec velcro	Com Velcro	Con velcro
	With motion	Avec mouvement	Con movimento	Con movimiento		New Item	Nouvel article	Novidade	Producto nuevo		Acrylic	Acrylique	Acrílico	Acrílico
	With light	Eclairé	Com luz	Con luz		Lightweight	Poids léger	Leve	Ligero		Economic	Économique	Económico	Económico
	LED Technology	Technologie LED	Tecnologia LED	Tecnologia LED		Extraweight	Poids supplémentaire	Peso extra	Peso extra		Tools required	Outils nécessaire	Montagem com ferramentas	Requiere herramientas
	Telescopic	Télescopique	Telescópico	Telescópico		Flexible	Flexible	Flexível	Basculante		No tools required	Aucun outil requis	Montagem sem ferramentas	No requiere herramientas
	Printed on fabric	Impression sur toile	Impressão têxtil	Impresión sobre textil		Magnetic	Aimanté	Magnético	Magnético	QTY	Quantity	Quantité	Quantidade	Cantidad
	With lock	Avec serrure	Com fechadura	Con cerradura		Plug-in	A Brancher	Elétrico	A corriente	NW	Net weight	Poids net	Peso líquido	Peso neto
	Rainproof	Imperméable	Impermeável	Impermeable		Big Sizes	Grandes tailles	De grandes dimensões	Grandes dimensiones	GW	Gross weight	Poids brut	Peso bruto	Peso bruto
	Suitable for outdoor use	Pour l'extérieur	Para exterior	Para exterior		Portrait	Verticale	Vertical	Vertical	CBM	Cubic meter	Metres cubes	Metro cúbico	Metro cúbico
	With spotlights	Avec spot	Com focos	Focos incluidos		Landscape	Horizontale	Horizontal	Horizontal	Size	Measures	Mesures	Medidas	Medidas



CONTACTE CON NOSOTROS ¡AHORA!

Escribanos, llámenos o venga a visitarnos a nuestras instalaciones. Estaremos encantados de atenderle. Para conocernos un poco más visite nuestra **web corporativa**.

DIRECCIÓN

La Cartelera y el Equipamiento Comercial, SL

Calle Luis I, 45 Nave A
Polígono Industrial de Vallecas
28031 Madrid

info@doncarteltienda.es

Teléfono gratuito de atención a clientes:
900 897 122

Horario de Lunes a Jueves:
De 9 a 14 h y de 16 a 18 h.

Horario Viernes: De 9 a 14 h.



@doncarteltienda



facebook.com/doncarteltienda



google.com/+DoncarteltiendaEstuweb



https://es.linkedin.com/in/doncarteltienda



https://www.flickr.com/photos/doncarteltienda



youtube.com/c/DoncarteltiendaEstuweb



instagram.com/doncarteltienda/



es.pinterest.com/doncarteltienda/doncarteltienda



doncarteltienda.es/blog/feed/

